

# HP xw6400 Workstation Service and Technical Reference Guide

---

User Guide



**Copyright Information**

© 2006 Copyright Hewlett-Packard Development Company, L.P.

**Warranty**

Hewlett-Packard Company shall not be liable for technical or editorial errors or omissions contained herein or for incidental or consequential damages in connection with the furnishing, performance, or use of this material. The information in this document is provided "as is" without warranty of any kind, including, but not limited to, the implied warranties of merchantability and fitness for a particular purpose, and is subject to change without notice. The warranties for HP products are set forth in the express limited warranty statements accompanying such products.

Nothing herein should be construed as constituting an additional warranty.

This document contains proprietary information that is protected by copyright. No part of this document may be photocopied, reproduced, or translated to another language without the prior written consent of Hewlett-Packard Company.

**Trademark Credits**

The HP Invent logo is a trademark of Hewlett-Packard Company in the U.S. and other countries.

Microsoft and Windows are trademarks of Microsoft Corporation.

UNIX is a registered trademark of The Open Group..

Intel and Xeon are registered trademarks of Intel Corporation in the U.S. and other countries.

Energy Star is U.S. registered mark of the United States Environmental Protection Agency.

432077-001

First Edition, June 2006



# Table of contents

## 1 Product overview

Product features .....	2
Component view .....	2
Front panel components .....	3
Rear panel components .....	4
Serial number and COA label location .....	4
Product specifications .....	6
Power supply .....	6
Power supply specifications .....	7
Power consumption .....	8
System fans .....	9
Resetting the power supply .....	9
Environmental specifications .....	9
PCI card slot power specification .....	10
ENERGY STAR .....	11
ENERGY STAR compliance .....	11

## 2 Installing or restoring the operating system

Installing the operating system and software .....	14
Microsoft Windows XP Professional .....	14
Installing or upgrading device drivers .....	14
Linux-preinstalled workstations .....	14
Starting up the Linux operating system .....	14
Restoring the Linux operating system .....	14
Downloading the latest HP driver CD contents .....	15
Installing the operating system with the HP driver CD contents .....	15
Upgrading device drivers .....	15
Linux-enabled workstations .....	15
Verifying hardware compatibility .....	15
Installing the Linux operating system .....	16
HP software .....	17
Restoring the Windows operating system .....	18
The RestorePlus! process .....	18
Creating a RestorePlus! CD .....	18
Restoring from RestorePlus! CDs .....	18
Restoring from RestorePlus! on the Recovery Partition .....	18
HP Backup and Recovery Manager restore points .....	19
Restoring from the HP Backup and Recovery Manager restore point CD or DVDs .....	19

Restoring from the HP Backup and Recovery Manager restore point on the Recovery Partition .....	19
Protecting the software .....	20
Ordering backup software .....	21

### 3 System management

Computer Setup (F10) Utility .....	24
BIOS ROM .....	25
Using the Computer Setup (F10) Utility .....	25
Computer Setup (F10) Utility menu .....	26
Desktop management .....	34
Initial configuration and deployment .....	34
Remote system installation .....	34
Updating and managing software .....	35
HP Client Manager Software .....	35
Altiris Client Management Solutions .....	35
System Software Manager .....	36
Proactive Change Notification .....	36
Subscriber's Choice .....	36
ROM flash .....	37
Remote ROM Flash .....	37
HPQFlash .....	37
FailSafe Boot Block ROM .....	37
Replicating the setup .....	38
Copying to a single workstation .....	39
Copying to multiple workstations .....	39
Dual-State Power Button .....	40
HP support website .....	40
Building blocks and partners .....	41
Asset tracking and security .....	41
Password security .....	42
Establishing a setup password using the Computer Setup (F10) Utility .....	43
Establishing a power-on password using workstation setup .....	43
Entering a power-on password .....	44
Entering a Setup Password .....	44
Changing a power-on or setup password .....	44
Deleting a power-on or setup password .....	45
National keyboard delimiter characters .....	45
Clearing passwords .....	46
Hood sensor (smart cover sensor) .....	46
Setting the hood sensor protection level .....	46
Hood lock (Smart cover lock) (optional) .....	47
Locking the hood lock (Smart cover lock): .....	47
Unlocking the hood lock (Smart cover lock): .....	47
Using the FailSafe key .....	47
Clearing Passwords .....	48
Cable lock provision (optional) .....	48
Security lock (optional) .....	48
Universal chassis clamp lock (optional) .....	48

Hood lock (Smart cover lock) (optional) .....	48
Hood sensor (Smart cover sensor) (optional) .....	48
Access panel key lock .....	48
Fault notification and recovery .....	48
Drive Protection System .....	49
ECC fault prediction and prefailure warranty .....	49
Thermal sensor .....	49

#### 4 Removal and replacement procedures

Service considerations .....	52
Read cautions, warnings, and safety precautions .....	52
Electrostatic discharge information .....	52
Generating static .....	52
Preventing electrostatic damage to equipment .....	53
Personal grounding methods and equipment .....	53
Grounding the work area .....	53
Recommended materials and equipment .....	54
Tools and software requirements .....	54
Screws .....	54
Special handling of components .....	54
Cables and connectors .....	55
Hard drives .....	55
Lithium coin cell battery .....	55
Customer Self-Repair .....	56
Predisassembly procedures .....	57
System board components .....	58
System board architecture .....	58
Removal and replacement of components .....	60
Disassembly order .....	60
Security lock (optional) .....	61
Cable lock (optional) .....	62
Universal chassis clamp lock (optional) .....	62
Side access panel .....	63
Front Bezel .....	64
Bezel blanks .....	65
Top cover .....	65
Hood sensor (Smart cover sensor) .....	66
Hood lock (Smart cover lock) (optional) .....	67
Front panel I/O device assembly .....	68
Power button assembly and system speaker .....	68
Memory fan .....	69
System fan assembly .....	71
Power supply .....	71
Memory .....	72
Memory module requirements .....	72
Removing memory module .....	72
Installing memory module .....	73
Installing a DIMM .....	74
PCI Slots .....	74
PCI retainer .....	75

Removing PCI retainer .....	75
Installing PCI retainer .....	76
PCI Express .....	76
PCI removal .....	77
PCI Express removal .....	78
PCI installation .....	79
PCI Express installation .....	80
Front PCI card guide and fan removal (optional) .....	81
Battery .....	82
Power connections to drives .....	83
Optical drive .....	84
Replacing optical drive data cable .....	86
Diskette drive (optional) .....	86
Hard drive .....	88
Replacing a hard drive .....	88
Removing a hard drive .....	88
Installing a hard drive .....	89
CPU heatsink .....	91
Removing the CPU heatsink .....	91
Replacing the CPU heatsink .....	92
Processor .....	94
Removing the processor .....	94
Replacing the processor .....	95
System board .....	96
Removing the system board .....	96
Replacing the system board .....	97

## 5 System diagnostics and troubleshooting

E-Support .....	100
Help & Support Center and E-Support .....	100
Troubleshooting checklist .....	101
LED color definitions .....	102
HP Insight Diagnostics Offline Edition .....	103
Key features and benefits .....	103
Theory of operation .....	103
Diagnostic Utility on CD .....	103
Downloading the latest diagnostic utility .....	104
User Interface .....	104
Navigation .....	104
Survey tab .....	104
Test tab .....	105
Status tab .....	106
Log tab .....	106
Help tab .....	107
Diagnostic error codes .....	108
Diagnostic LED codes .....	108
Troubleshooting scenarios and solutions .....	111
Solving minor problems .....	111
Solving power supply problems .....	112
Testing power supply .....	112



Solving diskette problems .....	114
Solving .....	116
Solving display problems .....	117
Solving audio problems .....	118
Solving printer problems .....	119
Solving keyboard and mouse problems .....	120
Solving front panel component problems .....	121
Solving hardware installation problems .....	122
Solving network problems .....	123
Solving memory problems .....	124
Solving processor problems .....	125
Solving CD-ROM and DVD problems .....	125
Solving Internet access problems .....	126
POST and error messages .....	128

#### **Appendix A Appendix A — SAS devices**

Supported SAS RAID configurations .....	138
SAS RAID 0 configuration .....	139
SAS RAID 1 configuration .....	140
SAS RAID 1E configuration .....	142

#### **Appendix B Appendix B — SATA devices**

Attaching SATA HDDs .....	146
Configuring system BIOS .....	147
Creating RAID volumes .....	148
Deleting RAID volumes .....	149

#### **Appendix C Appendix C — Connector pins**

Connector pin descriptions .....	152
----------------------------------	-----

#### **Appendix D Appendix D — System board designators**

#### **Appendix E Appendix E — Routine care**

General cleaning safety precautions .....	164
Maximizing the airflow .....	165
Cleaning the workstation case .....	166
Cleaning the keyboard .....	167
Cleaning the monitor .....	168
Cleaning the mouse .....	169

#### **Appendix F Appendix F — Additional password security and resetting CMOS**

Resetting the password jumper .....	172
Clearing and Resetting the CMOS .....	173
Using the CMOS Button .....	173
Using Computer Setup to Reset CMOS .....	174

#### **Appendix G Appendix G — Quick troubleshooting flowcharts**

Initial troubleshooting .....	176
-------------------------------	-----

No power .....	177
No power, part 1 .....	177
No power, part 2 .....	178
No power, part 3 .....	178
No video .....	180
No video, part 1 .....	180
No video, part 2 .....	181
No video, part 3 .....	181
Error messages .....	183
Error messages, part 1 .....	183
Error messages, part 2 .....	184
Error messages, part 3 .....	184
No operating system loading .....	186
No operating system loading from hard drive .....	187
No operating loading from hard drive, part 1 .....	187
No operating system loading from hard drive, part 2 .....	188
No operating system loading from hard drive, part 3 .....	188
No operating system loading from diskette drive .....	190
No operating system loading from CD-ROM drive .....	191
No operating system loading from network .....	192
Non-functioning device .....	193
<b>Appendix H Appendix H — PCI bus layout</b>	
PCI bus layout and device list .....	196

# 1 Product overview

This chapter presents an overview of the hardware components of the HP xw6400 Workstation.

- [Product features on page 2](#)
- [Product specifications on page 6](#)
- [ENERGY STAR on page 11](#)

# Product features

## Component view

The following image shows a typical HP xw6400 workstation. Drive configurations can vary.

For complete and current information on supported accessories and components, see <http://partsurfer.hp.com>.

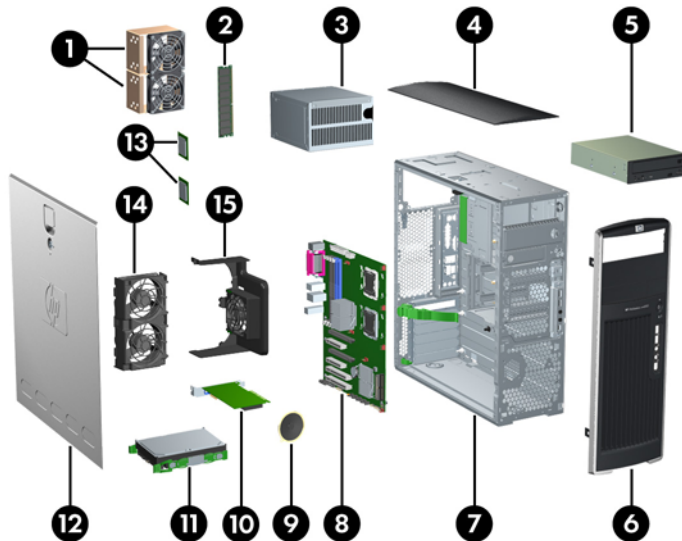

**Figure 1-1** Component view

**Table 1-1** Component view

Item	Description	Item	Description
1	CPU heatsinks	9	Speaker
2	Memory module	10	PCI Express graphics card
3	Power supply	11	Hard drive
4	Top cover	12	Side access panel
5	Optical drive	13	Processors
6	Front bezel	14	System fans
7	Chassis	15	Memory fan
8	System board		

## Front panel components

The following image shows a typical HP xw6400 Workstation. Drive configurations can vary.

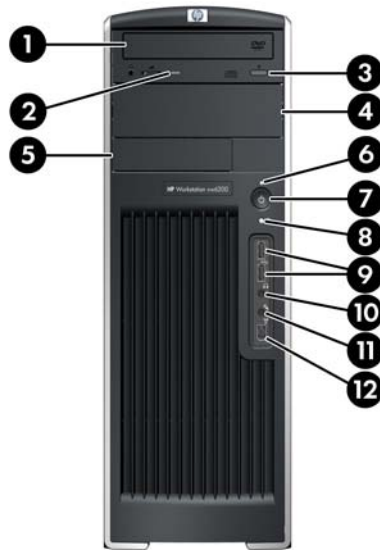
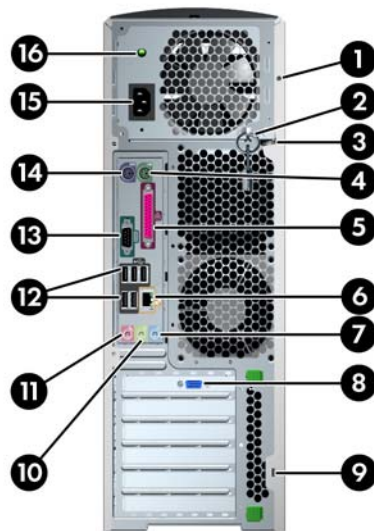

**Figure 1-2** Front panel components

**Table 1-2** Front panel components

Item	Description	Item	Description
1	Optical drive	7	Power button
2	Optical drive activity light	8	Hard drive activity light
3	Optical drive eject button	9	USB connectors (2)
4	5.25-inch drive bay	10	Headphone connector
5	3.5-inch drive bay	11	Microphone connector
6	Power on light	12	IEEE-1394a connector (optional)

## Rear panel components



**Figure 1-3** Rear panel components

**Table 1-3** Rear panel components

Item	Description	Item	Description
1	Universal chassis clamp slot	9	Cable lock slot
2	Side access panel key	10	Audio line-out connector (lime)
3	Padlock or cable loop	11	Microphone connector (pink)
4	PS/2 mouse connector (green)	12	USB connectors (5)
5	Parallel connector (burgandy)	13	Serial connector (teal)
6	RJ-45 network connector	14	PS/2 keyboard connector (purple)
7	Audio line-in connector (light blue)	15	Power cord connector
8	Graphics adapter	16	Built-In Self Test (BIST) LED

The rear panel connectors are labeled with industry-standard icons and colors to assist you in connecting your peripheral devices.

## Serial number and COA label location

Each workstation has two unique serial number labels. The serial number labels **1** are located on the side panel of the unit and on the rear panel **2**. Keep this number available when contacting customer service for assistance. Systems preinstalled with Microsoft® Windows® XP also have a certificate of authentication (COA) label **2**.



**Figure 1-4** Serial number and COA label location

# Product specifications

The following table lists the physical dimensions for the HP xw6400 Workstation.

**Table 1-4** Physical characteristics

Weight (typical configuration)	16 kg (35 lb)
Tower dimensions	441 mm (17.4 in.) tall 165 mm (6.5 in.) wide 440 mm (17.3 in.) deep
Rack-mount dimensions (top cover and foot removed)	165 mm (6.5 in.) tall, less than 4U 425 mm (16.75 in.) wide (fits in a standard 19-in. rack) 440 mm (17.3 in.) deep

## Power supply

This section describes power supply specifications for the HP xw6400 Workstation.

- +3.3V—PCI, MCH, ICH5, PXH, LAN, SATA, and SAS hard drives, and on-board logic
- +5V—Storage (disk, optical, diskette), PCI, audio, USB, input to on-board regulator, and on-board logic
- +12V-B—PCI, fans, and input to on-board regulators that supply 1.2V
- +12V-D—Storage (disk, optical, diskette), PCI Express x16 auxiliary connector
- +12V-CPU0—Input to on-board regulator that supplies power for CPU0 and input to on-board regulators that supply 1.5 V and 1.8 V to memory slots
- +12V-CPU1—Input to on-board regulator that supplies power for CPU1
- -12V—PCI
- 5VSB—Standby mode circuitry

**Table 1-5** Power supply voltage

Voltage	Minimum	Maximum
3.3 V	3.2 V	3.5 V
5.1 V	4.8 V	5.3 V
12 V-CPU0	11.5 V	12.6 V
12 V-CPU1	11.5 V	12.6 V
12 V-A	11.5 V	12.6 V
12 V-D	11.5 V	12.6 V
V12N	-10.9 V	-13.2 V
5.08 VSB	4.8 V	5.3 V



**Table 1-6** Power supply current

Current	Minimum	Operating	Continuous	Maximum
3.3 V	0 A	0.5 A	18 A	20 A
5.1 V	0 A	0.5 A	18 A	20 A
12 VCPU0	0 A	3.1 A	17 A	19 A
12 VCPU1	0 A	3.1 A	10 A	15 A
12 V-D	0 A	3.1 A	12 A	15.5 A
12 V-B	0 A	3.1 A	15.5 A	18.8 A
V12N	0 A	0 A	0.2 A	0.3 A
5.08 VSB	0 A	0 A	2.1 A	.32 A



**WARNING!** Do not exceed 110 W of combined power on 5 V and 3.3-V outputs.

Do not exceed 552 W of combined power on the 12-V (CPU0/CPU1/B/D) outputs.

Do not exceed 240 VA on any of the 12-V outputs (CPU0, CPU1, B, and D) power combination.

Do not exceed 575 W of total continuous output power.

## Power supply specifications

**Table 1-7** Power supply specifications

Power supply	575 W custom power supply (wide ranging, active PFC)	
Operating voltage range	90–269 VAC	
Rated voltage range	100–240 VAC	118 VAC
Rated line frequency	50/60Hz	400Hz
Operating line frequency range	47–66 Hz	393–407Hz
Rated input current	10A @ 100–120 VAC	9.7 @ 118 VAC
	6A @ 200–240 VAC	
Heat dissipation	Typical 980 BTU/hr	(247 kg-cal/hr)
(Configuration and software dependent)	Maximum 3413 BTU/hr	(860 kg-cal/hr)
Power supply fan	92x25 mm variable speed	
FEMP standby power compliant @ 115V (<2 W in S5 - power off)	Yes	

**Table 1-7** Power supply specifications (continued)

Blue Angel Compliant (<5W in S5 - power off)	N/A
Power consumption in ES mode—suspend to RAM (S3) (Instantly available PC)	<7W

## Power consumption

The following table lists the power consumption for a typical configuration based on primary power consumptions:

- Processors (2 x 2.66 GHz)
- Memory (1 x 1 GB 667 MHz)
- Graphics (FX1500)
- Hard drives (2 x 80 GB SATA)
- Optical drive (1)
- One monitor, powered separately

**Table 1-8** Energy consumption

	115 VAC		230 VAC		100 VAC	
	LAN enabled	LAN disabled	LAN enabled	LAN disabled	LAN enabled	LAN disabled
Windows idle (S0)	169 W		168 W		168 W	
Windows busy (S0)	287 W		284 W		290 W	
Sleep (S3)	3.4 W	4.3 W	6.1 W	3.9 W	3.4 W	3.2
Off (S5)	2.2 W	2.0 W	5.1 W	3.0 W	2.1 W	2.0 W

**Table 1-9** Heat dissipation\*\*

	115 VAC		230 VAC		100 VAC	
	LAN enabled	LAN disabled	LAN enabled	LAN disabled	LAN enabled	LAN disabled
Windows idle (S0)	577 BTU/hr		573 BTU/hr		573 BTU/hr	
Windows busy (S0)	980 BTU/hr		969 BTU/hr		990 BTU/hr	
Sleep (S3)	12 BTU/hr	15 BTU/hr	21 BTU/hr	13 BTU/hr	12 BTU/hr	11 BTU/hr
Off (S5)	7.5 BTU/hr	6.8 BTU/hr	17.4 BTU/hr	10 BTU/hr	7.2 BTU/hr	7 BTU/hr



**NOTE** \*Energy Star low energy mode

\*\*Heat dissipation is calculated based on the measured watts, assuming the service level is attained for one hour.

This product is in compliance with US executive order 13221, WOL (wake on LAN) disabled.

## System fans

The workstation includes two rear system fans, one memory fan, one CPU heatsink fan for each processor, and one power supply fan. An optional front system fan is available for special considerations.

## Resetting the power supply



If an overload triggers the power supply overload protection, all power is immediately disconnected. To reset the power supply unit:

1. Disconnect the power cord.
2. Determine what caused the overload and fix the problem.
3. Reconnect the power cord and reboot the workstation.

## Environmental specifications

This section describes environmental specifications of your workstation.

**Table 1-10** Environmental specifications

Temperature (operating)	40° to 95°F (5° to 35°C)
Temperature (non-operating)	−40° to 140°F (−40° to 60°C)
Humidity (operating)	8% to 85% RH, non-condensing
Humidity (non-operating)	8% to 90% RH, non-condensing
Altitude (operating)	0 to 10,000 ft (3,048 m)
Altitude (non-operating)	0 to 30,000 ft (9,144 m)
Shock (operating)	1/2-sine: 40 G, 2–3 ms
Shock (non-operating)	1/2-sine: 160 cm/s, 2–3 ms (~100g) Square: 20 G, 422 cm/s
	 <b>NOTE</b> Values represent individual shock events and are not indicative of repetitive shock events.
Vibration (operating)	Operating random: 0.5 G rms, 5–300 Hz
Vibration (non-operating)	Random: 2.0 G(rms), 10–500 Hz
	 <b>NOTE</b> Values are not indicative of continuous vibration.
Energy Star® 1999 Spec Compliant	Yes (as an option)

## PCI card slot power specification

**Table 1-11** PCI and PCI Express slot power specifications

Slot#	Slot type	Slot power (maximum)
1	PCI Express x16 graphics	130 W**
2	PCI Express x8 (4)	25 W*
3	PCI Express x16 (4)	25 W*
4	PCI Express x8 (4)	25 W*
5	PCI (32-bit, 33-MHz)	10 W*
6	PCI (32-bit, 33-MHz)	10 W*

\* In addition to these slot power specifications, the overall power consumption of the system (including I/O cards, processor, and memory) must not exceed the maximum ratings of the system power supply. See [Power supply specifications on page 7](#) for details.

\*\* Includes 55W maximum from the system board connector, and 75 W maximum from the auxiliary graphics power connector.



**NOTE** The primary graphics card must be installed in slot 1. The secondary graphics card (and only an NVS285 or NVS440) must be installed in slot 3.

For hardware specifications of other system components, such as graphics cards or optical drives, refer to the website of the specific manufacturer.

# ENERGY STAR

The ENERGY STAR® program, a government-backed initiative, promotes energy efficiency by identifying ways to reduce energy consumption. Select HP workstations participate in the ENERGY STAR program.



---

**NOTE** ENERGY STAR is not supported on Linux-based workstations.

---

For those workstations that support ENERGY STAR and have it enabled, the power management features will be set as follows:

- Monitor—Enters power savings mode after 20 minutes of inactivity.
- System—Enters standby mode after 20 minutes of inactivity.



---

**NOTE** If you must restore the operating system, reset the ENERGY STAR settings (if applicable) after the restore.

---

To verify the factory default power settings for your product, select **Start>Control Panel** and double-click **Power Options**.

## ENERGY STAR compliance

HP products purchased with the ENERGY STAR configuration are compliant with the U.S. Environmental Protection Agency (EPA) Computers Program. The EPA ENERGY STAR configuration does not imply endorsement by the EPA. As an ENERGY STAR partner, HP has determined that products with the ENERGY STAR configuration meet the ENERGY STAR guidelines for energy efficiency.

The ENERGY STAR Computers Program was created by the EPA to promote energy efficiency and reduce air pollution through more energy-efficient equipment in homes, offices, and factories. HP products achieve this result by reducing the power consumption when not being used.

ENERGY STAR on HP Workstations uses Advanced Configuration and Power Interface (ACPI) power management. The system can wake as a result of a user action (keyboard or mouse) or from the network or a modem.

The Power Management feature, when used in conjunction with an external ENERGY STAR-compliant monitor, supports the power-down features of the monitor. The Power Management feature allows an external monitor to go into low-power mode when the Energy Save timeout occurs.



---

**NOTE** Using the ENERGY STAR Save Monitor feature with non-ENERGY STAR-compliant monitors might cause video distortion when the Energy Save timeout occurs.

---



## 2 Installing or restoring the operating system

This chapter describes the installation and restoration of the operating system.

- [Installing the operating system and software on page 14](#)
- [HP software on page 17](#)
- [Restoring the Windows operating system on page 18](#)
- [HP Backup and Recovery Manager restore points on page 19](#)
- [Protecting the software on page 20](#)
- [Ordering backup software on page 21](#)

If your workstation was shipped with a preinstalled operating system, it is configured automatically the first time your workstation is powered on.

Adding optional hardware devices to your workstation before the operating system successfully installs can cause errors and prevent the operating system from installing properly.



---

**CAUTION** After the automatic installation has begun, do not power off your workstation until this process completes. Powering off your workstation during the installation process might damage the software that runs the system.

---

# Installing the operating system and software

The following sections discuss operating system and HP software installation procedures.

## Microsoft Windows XP Professional

The first time you power on your workstation, you are prompted to select a language for the operating system. After selecting the language, read and follow the instructions on the screen to complete the installation of the operating system. This process takes approximately 10 minutes, depending on the system hardware configuration. During the process, do not power off your workstation unless you are directed to do so.

## Installing or upgrading device drivers

To install hardware devices, such as a printer, a display adapter, or network adapter after the operating system installation is completed, the operating system needs access to the appropriate software drivers for the devices. Device drivers are usually provided on a CD supplied with the peripheral device.

Some existing peripheral devices might not have been shipped with drivers developed for Windows XP. To locate the most current device drivers, see <http://www.hp.com/go/workstationsupport>.

## Linux-preinstalled workstations

If you have a Linux-preinstalled workstation, follow the instructions in this section to set up your operating system and software.

After the boot process completes, you can view additional HP Linux documentation by opening your Internet browser (the browser is automatically set to use the local HP documentation page as its default). You can also access Linux Web links for Red Hat (Internet access required) by using your Internet browser.

For additional information about setting up Linux-preinstalled or Linux-enabled workstations, refer to the *HP User Manual for Linux* at [http://www.hp.com/support/linux\\_user\\_manual](http://www.hp.com/support/linux_user_manual).

For more information about HP and Linux, see <http://www.hp.com/linux>.

## Starting up the Linux operating system

The first time your workstation is booted, the Red Hat First Boot utility displays. This program enables you to enter your password, network, graphics, time, and keyboard settings for your workstation.



**CAUTION** After the automatic installation has begun, do not power down your workstation until the process is complete. Powering down your workstation during the installation process might damage the software that runs your workstation or prevent its proper installation.

When you enable the YPBind feature in the Network tab of the Linux Setup Tool, you might get a blank screen for about 15–30 seconds after you have selected and saved all of your settings and exited the utility. This behavior is normal. The boot process continues its execution after the screen returns.

## Restoring the Linux operating system

To restore the Linux operating system, the HP Driver CD and Red Hat box set are required. Download the latest HP Driver CD to get any new enhancements.



Linux does not support mixed drive types for a manufacturing preload. When restoring the operating system, mixed drive types can be handled with the restoring media.

### Downloading the latest HP driver CD contents

See <http://www.hp.com> and select **Software and Drive Downloads**. Find your workstation and operating system. Select your driver CD under **Software**, and follow the directions under **Release Notes**.

### Installing the operating system with the HP driver CD contents

1. Boot your workstation from the Red Hat box set Binary CD 1.
2. Insert the Linux operating system CDs from the Red Hat box set as prompted.
3. Continue following the prompts until the operating system is successfully installed.
4. Configure the X server to start on reboot.
5. Reboot your workstation.
6. Follow the prompts to set up your system with the Red Hat First Boot utility.
7. When prompted in First Boot to add additional CDs, insert the HP Driver CD into the CD-ROM tray of your workstation.
8. Click **Install** next to “Additional CDs.” The HP Driver CD window opens.
9. Click **Press** to begin install.

When the install is done, you will have two options— **Reboot now...** on the left side and **Press to continue, reboot later...** on the right side.

10. Click **Reboot now...**

### Upgrading device drivers

To upgrade a Linux device driver, see <http://www.hp.com/go/workstationsupport>.

### Linux-enabled workstations

Linux-enabled workstations are not preinstalled with Linux. They require the HP Installer Kit for Linux and the purchase of a Red Hat box set. The Installer kit includes the HP CDs necessary to complete the installation of all versions of the Red Hat box set that have been verified to work on HP workstation hardware.

### Verifying hardware compatibility

To determine which Linux versions have been verified to work on HP workstation hardware:

1. Go to [http://www.hp.com/support/linux\\_hardware\\_matrix](http://www.hp.com/support/linux_hardware_matrix).
2. Select your HP workstation model.

## Installing the Linux operating system

To install the Linux operating system on your Linux-enabled system, follow the instructions for [Restoring the Linux operating system on page 14](#) in this chapter.

For more information concerning the setup of Linux-preinstalled or Linux-enabled workstations, refer to the *HP User Manual for Linux* located at [http://www.hp.com/support/linux\\_user\\_manual](http://www.hp.com/support/linux_user_manual).

For more information about HP and Linux, see <http://www.hp.com/linux>.

## HP software

The following HP software may be installed on your workstation depending on the operating system and options:

- Computer Setup (F10) Utilities and diagnostic features
- HP Support Software including device drivers
- Security Management tools (optional)
- Software Support Management tools

Additional software is available for download:

- HP Client Manager Software is available at <http://www.hp.com/go/easydeploy>.
- System Software Manager is available at <http://www.hp.com/go/ssm>.



**NOTE** Additional HP software might be required in certain situations.

---

# Restoring the Windows operating system

Your workstation has a several methods to restore your Windows XP operating system to a near-factory state, or to the state of the system at a predefined snapshot in time. Your system has a recovery partition on the system hard drive that contains software and data required for the restore process as described in the following sections.

## The RestorePlus! process

The Windows operating system and device drivers (for devices shipped with the system) are reinstalled using this process. Some application software may not be restored using the RestorePlus! process. In this case you must install the application software from the appropriate application CD. The RestorePlus! process can be executed from CD or from the recovery partition contained on your system hard drive.



**CAUTION** Backup your data before you attempt any operating system restore. All data on the Windows partition will be deleted when you restore using the RestorePlus! process. However, the recovery partition on the system drive and other partitions should not be affected.

## Creating a RestorePlus! CD

You can create a set of the CDs from your system if you have a CD burner. When you first boot your system, you will be prompted to make CDs for RestorePlus!, the Windows operating system, and a supplemental HP Backup and Recovery Manager CD. (There may be additional CDs you can create depending on the options you purchased.) You also have the option to move images of the CDs to another location, such as a network share, to be burned to CD at a later time or from another system.

## Restoring from RestorePlus! CDs

The RestorePlus! process can be started by booting from the RestorePlus! CD.

## Restoring from RestorePlus! on the Recovery Partition

Follow these steps to start the RestorePlus! process from the Emergency Recovery menu:

1. Boot the workstation.
2. Press the **F11** key when prompted during the boot process to enter the Emergency Recovery menu. The F11 prompt appears briefly during the boot process.
3. Select **Recover PC's factory installed operating system, drivers, utilities, and applications** from the Emergency Recovery menu.



**NOTE** Some applications may not be restored using this method.

# HP Backup and Recovery Manager restore points

HP Backup and Recovery Manager is preinstalled on your workstation. This software allows you to backup and restore your system and data. You will be prompted to make RestorePlus! CDs at the first boot of the system. An Initial Restore Point (IRP) will be created automatically. This restore point is a complete snapshot of the system partition at the time the IRP was created. The IRP is stored in the recovery partition on the system hard drive, but you can also burn the IRP to CDs, DVDs, or copy it to another location. The restore point can be used to return the system partition back to the state the system was when captured.

## Restoring from the HP Backup and Recovery Manager restore point CD or DVDs

The HP Backup and Recovery Manager (HPBR) restore point can be burned to CD or DVDs and used to restore the system. Typically you would use the CD/DVD set if the hard drive has been replaced or all partitions have been corrupted. Boot the system from the HPBR restore point CD/DVD and follow the online instructions.

## Restoring from the HP Backup and Recovery Manager restore point on the Recovery Partition

The HP Backup and Recovery Manager (HPBR) Initial Restore Point is stored in the system recovery partition and can be restored using the Emergency Recovery menu. Boot your system and press the **F11** key when prompted to enter the Emergency Recovery menu. The F11 prompt appears briefly during the boot process. From the Emergency Recovery menu, choose **Recover PC to a specific point in time** and follow the instructions.

## Protecting the software

To protect software from loss or damage, keep a backup copy of all system software, applications, and related files stored on the hard drive. See the operating system or backup utility documentation for instructions on making backup copies of data files.

## Ordering backup software

If you are unable to create system recovery CDs or DVDs, the HP Restore Plus CD set can be obtained through product support on <http://www.hp.com/support>.



---

**NOTE** Before calling HP to order the software, be sure to have the serial number of your workstation available.

---





# 3 System management

This section describes the various tools and utilities that allow for the system management of the workstation.

- [Computer Setup \(F10\) Utility on page 24](#)
- [Desktop management on page 34](#)

# Computer Setup (F10) Utility

The Computer Setup (F10) Utility enables you to:

- Change factory default settings and set or change the system configuration, which might be necessary when you add or remove hardware.
- Determine if all of the devices installed on the workstation are recognized by the system and functioning properly.
- Determine information about the operating environment of the workstation.
- Solve system configuration errors detected but not automatically fixed during the Power-On Self-Test (POST).
- Establish and manage passwords and other security features.
- Establish and manage energy-saving time-outs (not supported for Linux platforms).
- Modify or restore factory default settings.
- Set the system date and time.
- Set, view, change, or verify the system configuration, including settings for processor, graphics, memory, audio, storage, communications, and input devices.
- Modify the boot order of installed mass storage devices such as SATA, SAS, diskette drives, optical drives, network drives, and LS-120 drives.
- Configure the boot priority of SATA and SAS hard drive controllers.
- Enable or disable Network Server Mode, which enables the workstation to boot the operating system when the power-on password is enabled with or without a keyboard or mouse attached. When attached to the system, the keyboard and mouse remain locked until the power-on password is entered.
- Select POST Messages Enabled or Disabled to change the display status of POST messages. POST Messages Disabled suppresses most POST messages, such as memory count, product name, and other non-error text messages. If a POST error occurs, the error is displayed regardless of the mode selected. To manually switch to POST Messages Enabled during POST, press any key (except **F1** through **F12**).
- Establish an Ownership Tag, the text of which is displayed each time the system is powered on or restarted.
- Enter the Asset Tag or property identification number assigned by your company to this workstation.
- Enable power-on password prompting during system restarts (warm boots) and power-on.
- Secure the integrated I/O functionality, including the serial, USB, or parallel ports, audio, or embedded NIC, so that the I/O functionality cannot be used until they are unsecured.
- Enable or disable removable media boot ability.
- Enable or disable removable media write ability (when supported by hardware).

- Replicate your system setup by saving system configuration information on diskette and restoring it on one or more workstations.
- Execute self-tests on specified SATA and SAS hard drives (when supported by the drive).

## BIOS ROM

The BIOS of the computer is a collection of machine language programs stored as firmware in ROM. The BIOS ROM includes such functions as POST, PCI device initialization, plug-in-play support, power management activities, and the Computer Setup (F10) Utility. The firmware contained in the BIOS ROM supports the following systems and specifications:

- Microsoft® Windows Hardware Quality Labs (WHQL)
- Alert-On-LAN (AOL) and Wake-On-LAN (WOL)
- ACPI 1.0 and 2.0 and OnNow
- SMBIOS 2.5
- PC98/99/00 and NetPC
- HP Preboot Execution Environment (PXE) boot ROM for the integrated LAN controller
- BIOS Boot Specification 1.01
- Enhanced Disk Drive Specification 3.0
- “El Torito” Bootable CD-ROM Format Specification 1.0
- AT Attachment Packet Interface (ATAPI) Removable Media Device BIOS Specification 1.0
- Multiprocessor Specification (MPS) 1.4 (for booting Linux Symmetrical Multi Processing (SMP))
- Alert Standard Format (ASF) 1.0

The BIOS ROM is a 1-MB Intel Firmware Hub (or Firmware Hub-compatible) part. The runtime portion of the BIOS resides in a 96-Kb block from E8000h to FFFFFh (approximation). Advanced Configuration and Power Interface (ACPI) code and data take about 128 Kb below TOLM (top of low memory, last RAM address below 4 GB).

## Using the Computer Setup (F10) Utility

You can only open the Computer Setup (F10) Utility by powering on the workstation or restarting the workstation. To access the Computer Setup (F10) Utility menu:

1. Power on or restart the workstation.
2. Press the **F10** key as soon as your display is active and you see **F10=Setup** appear in the lower right corner of the screen.



**NOTE** If you do not press **F10** at the appropriate time, try again. Turn the workstation off, then on, and press **F10** again to access the utility, or press the **Ctrl + Alt + Delete** keys before boot if you miss the opportunity to press **F10**.

3. Select your language from the list and press the **Enter** key. In the Computer Setup (F10) Utility menu, five headings are displayed: **File**, **Storage**, **Security**, **Power**, and **Advanced**.

4. Use the arrow (left and right) keys to select the appropriate heading. Use the arrow (up and down) keys to select the option you want, and press **Enter**.
5. To apply and save changes, select **File>Save Changes** then select **Exit**.
  - If you have made changes that you do not want applied, select **Ignore Changes** and **Exit**.
  - To reset to factory settings, select **File>Default setup>Restore Factory Settings as Default**. Press **F10** to accept the changes. Select **Apply Defaults and Exit**. This option restores the original factory system defaults.



**CAUTION** Do not power off the workstation while the ROM is saving your Computer Setup (F10) Utility changes because the Complementary Metal-Oxide Semiconductor (CMOS) could become corrupted. After you exit the F10 Setup screen, it is safe to disconnect power from the workstation.

## Computer Setup (F10) Utility menu



**NOTE** The following content is subject to change with new BIOS releases, so your menu might be different than shown.



**Table 3-1** Computer Setup (F10) Utility menu descriptions

Heading	Option	Description	
File	System Information	Lists product name, SKU number, processor type/speed/stepping, cache size (L1/L2), memory type and size, integrated Media Access Control (MAC) for enabled or embedded NIC (if applicable), system BIOS type, chassis serial number, and asset tracking number.	
	About	Displays copyright information.	
	Set Time and Date	Enables you to set system time and date.	
	Flash System ROM	Enables you to flash (update) system BIOS using any supported removable mass storage device (CD-ROM, USB drive, floppy).	
	Replicated Setup	Save to Removable Media	Saves the current F10 Setup configuration to a text file called <b>CPQSETUP.TXT</b> , which can be used for Replicated Setup functions.
		Restore from Removable Media	Restores previous F10 Setup configuration from a text file called CPQSETUP.TXT, which can be used for Replicated Setup functions.
		Default Setup	Save Current Settings as Default  Stores the current F10 Setup configuration into the physical ROM as the default.
Apply Defaults and Exit	Restore Factory Settings as Default	Restores the original factory settings to the F10 Setup configuration information in the physical ROM as the default.	
	Apply Defaults and Exit	Saves the selected default settings (previously-saved user settings or factory settings) into Non-Volatile Random Access Memory (NVRAM) and exits.	
	Ignore Changes and Exit	Exits the Computer Setup (F10) Utility without applying or saving any changes.	

**Table 3-1** Computer Setup (F10) Utility menu descriptions (continued)

Heading	Option	Description
	Save Changes and Exit	Saves changes to system configuration and exits the Computer Setup (F10) Utility.
Storage	Device Configuration	Lists all installed storage devices.
		When a device is selected, detailed information and options are displayed.
		Hard Disk
		Identifies the hard disk drives on the system by model, firmware, serial number, connector color, emulation type, multisector transfers, and translation mode.
		CD-ROM
		Identifies the CD-ROM drives on the system.
		Diskette Type <i>(for legacy diskette drives only)</i>
		Identifies the highest capacity media type accepted by the diskette drive. Options are 3.5" 1.44 MB, 5.25" 1.2 MB, and Not Installed.
	Default Values	Enables you to set the default values for , SAS, and SATA devices.
	Translation Mode <i>(SATA disks only)</i>	Enables you to select the translation mode to be used for the device, which enables the BIOS to access disks partitioned and formatted on other systems and might be necessary for users of older versions of UNIX (R) (for example, SCO UNIX version 3.2). Options are Bit-Shift, LBA Assisted, Off, and Automatic.
		 <p><b>NOTE</b> The automatic option has been added to allow BIOS to automatically determine the translation mode used to configure a previously formatted SAS, SATA, or USB mass storage device. This functionality prevents you from having to know how the mass storage device was previously formatted.</p>
		Ordinarily, the translation mode selected automatically by the BIOS should not be changed. If the selected translation mode is not compatible with the translation mode that was active when the disk was partitioned and formatted, the data on the disk will be inaccessible.
Storage Options	Removable Media Boot	Enable or disables ability to boot the system from removable media.
		Legacy Diskette Write
		Enables or disables ability to write data to legacy media.
		BIOS DMA Data Transfers
		Determine the point where BIOS enables DMA transfers for both SAS and SATA devices when possible during POST to increase transfer speed.
	SATA Emulation	Sets the SATA emulation mode with the following options:
	RAID+AHCI	This option is the default and offers best performance. It requires one of the two Intel SATA option ROMs to run. In this mode, the Option ROM manages the drives, so they are not shown in Device Configuration.

**Table 3-1** Computer Setup (F10) Utility menu descriptions (continued)

Heading	Option	Description
		<p>Separate Controller</p> <p>Offers standard SATA supports (four ports only).</p> <p>Combined Controller</p> <p>Makes the SATA controller look like an controller and offers best compatibility (two ports only).</p>
		<p>Primary SATA Controller</p> <p>Allows you to disable the SATA controller primary SATA ports from the BIOS perspective, but the controller is not hidden. The BIOS will ignore these ports and will not configure and enumerate any devices connected to it. However, the operating system can re-enable and enumerate devices upon booting.</p>
		<p>Secondary SATA Controller</p> <p>Allows you to disable the SATA controller secondary SATA ports from the BIOS perspective, but the controller is not hidden. The BIOS will ignore these ports and will not configure and enumerate any devices connected to it. However, the operating system can re-enable and enumerate devices upon booting.</p>
DPS Self-Test		<p>Selects the Drive Protection System (DPS) Self-Test (also called DST, Drive Self-Test). You are prompted for the drive on which to run the test.</p> <p> <b>NOTE</b> This option is only offered for SATA and SAS hard drives.</p> <p>The test could take a while for large drives.</p>
Boot Order		<p>Enables you to configure the boot, diskette drive, and hard drive orders by physically reordering the menu entries. Boot Order presents these selections:</p> <ul style="list-style-type: none"> <li>• ATAPI CD-ROM Drive</li> <li>• USB device</li> <li>• Hard Drive</li> <li>• Integrated SATA</li> <li>• Integrated</li> <li>• Broadcom Ethernet controller</li> <li>• Diskette Drive</li> </ul> <p>Boot devices can be disabled from participating in the boot order process. These order changes are reconciled with the IPL/BCV historical information and stored in the physical ROM part when the F10 Setup changes are confirmed with File/Save Changes and Exit.</p> <p> <b>NOTE</b> MS-DOS drive lettering assignments might not apply after a non-MS-DOS operating system has started.</p> <p><b>Shortcut to Temporarily Override Boot Order</b></p> <p>To boot <b>one time</b> from a device other than the default device specified in Boot Order, restart the workstation and press <b>F9</b> when the <b>F9=Boot Menu</b> message appears on the screen. After POST completes, a list of bootable devices is displayed. Use the arrow keys to select the preferred bootable device and press <b>Enter</b>. The workstation then boots from the selected non-default device for this one time.</p>
Security	Setup Password	Allows you to set and enable setup (administrator) password.

**Table 3-1** Computer Setup (F10) Utility menu descriptions (continued)

Heading	Option	Description
		 <p><b>NOTE</b> If the setup password is set, you must enter Computer Setup (F10) Utility to change it, flash the ROM, and make changes to certain plug-and-play settings under Windows.</p>
	Power-On Password	Allows you to set and enable power-on password.
	Password Options	<p>Lock Legacy Resources</p> <p>Prevents the operating system from reassigning plug-and-play resources for serial, parallel, and diskette legacy I/O devices.</p> <p>Network Server Mode</p> <p>Enable or disable Network Server Mode, which enables the workstation to boot the operating system when the power-on password is enabled with or without a keyboard or mouse attached. When attached to the system, the keyboard and mouse remain locked until the power-on password is entered.</p> <p>Password Prompt on Warm Boot</p> <p>Sets the Password Prompt on Warm Boot function. If disabled, the BIOS will only prompt for a password after power-on</p>
	Smart Cover	Allows you to disable cover removal sensor or to notify user if sensor has been activated. If disabled, the BIOS will only prompt for a password after power-on.
	Device Security	<p>Makes the following devices available or unavailable to the system:</p> <ul style="list-style-type: none"> <li>• Serial port</li> <li>• Parallel port</li> <li>• All USB ports</li> <li>• Front USB ports</li> <li>• System audio</li> <li>• Controller security</li> <li>• SATA controller security</li> <li>• IEEE 1394 controller</li> <li>• Network controller</li> </ul> <p>For each device, <b>Device available</b> is the default setting and allows the operating system access to the device. <b>Device Hidden</b> makes the device unavailable; it is disabled by the BIOS and cannot be enabled by the operating system.</p>
	Network Service Boot	Enables a Network Service Boot, which boots using the NIC PXE option ROM. In this case, the actual boot image resides on a remote server. When enabled, you can set the boot order of the NIC PXE option ROM and force a network boot by pressing <b>F12</b> during POST.
	System IDs	<p>Asset Tag</p> <p>A 16–byte string identifying the system.</p> <p>Ownership Tag</p> <p>An 80–byte string identifying ownership of the system. This tag is displayed on the screen during POST.</p> <p>UUID (Universal Unique Identifier)</p>

**Table 3-1** Computer Setup (F10) Utility menu descriptions (continued)

Heading	Option	Description
		Can only be updated if the current chassis serial number is invalid. (These ID numbers are normally set in the factory and are used to uniquely identify the system.)
		Keyboard
		Enables you to set the keyboard locale for System ID entry.
	OS Security	Data Execution Prevention
		Sets Data Execution Prevention mode in the processors. This mode prohibits code from running in pages that were set up as data pages and prevents attacks such as buffer overflows. Operating system support is required for this feature.
		Intel Virtualization Technology
		Enables Intel Virtualization Technology in the processors. Additional virtualization software (such as VMware) is required to use virtualization. This feature requires a complete power down to be activated. Operating system support is required for this feature.
Power	OS Power Management	Runtime Power Management
		Enables Enhanced Intel SpeedStep Technology (EIST) and Demand-Based Switching (DBS). This allows the operating system to tune processor performance states depending on load.
		Idle Power Savings
		When set to <b>Enhanced</b> , this enables C1E, the high-efficiency processor halt state. When the operating system puts a processor in idle mode, this reduces its power consumption
		ACPI S3 Support
		Enables the suspend-to-RAM state. This option is mostly for troubleshooting purposes; the operating system will never enter S3 if one of its drivers does not support that state. Enabled by default; disabled for troubleshooting.
		ACPI S3 Hard Disk Reset
		When enabled, the BIOS sends a "drive reset" command to the SAS and SATA drives when resuming from S3, before returning to the operating system.
		ACPI S3 PS2 Mouse Wake Up
		Allows the PS/2 mouse to wake from ACPI S3. PS/2 keyboards are always enabled. (Disabling this means that nudging the mouse will not trigger a system wake.)
		USB Wake on Device Insertion
		Enables the USB controllers to generate a wake event when a device is plugged in while the system is in an ACPI sleep state. The matching USB controller must be set to wake the system (from Windows, this is done from Device Manager, using the <b>Power Management</b> tab for that controller, and setting the <b>Allow this device to wake up the system</b> check box).
	Hardware Power Management	SATA Power Management
		Allows you to enable or disable SATA power management. This option still works when the controller is in AHCI/RAID mode.
	Thermal	Fan Idle Mode
		This setting changes the minimum fan speed. The fans are still automatically controlled.
Advanced **	Power-On Options	POST Messages
		Enables you to select between splash screen and text-mode startup.
		F9 Prompt (enable/disable)



**Table 3-1** Computer Setup (F10) Utility menu descriptions (continued)

Heading	Option	Description
		Enabling this feature displays <b>F9=Boot Menu</b> during POST. Displaying this feature prevents the text from being displayed, but pressing <b>F9</b> still forces the system to attempt booting from the network.
	F10 prompt (enable/disable)	Enabling this feature displays <b>F10=Setup</b> during POST. Disabling this feature prevents the text from being displayed, but pressing <b>F10</b> still accesses the Setup screen.
	F12 prompt (enable/disable)	Enabling this feature displays <b>F12=Network Service Boot</b> during POST. Disabling this feature prevents the text from being displayed but pressing <b>F12</b> still forces the system to attempt booting from the network.
	Option ROM* Prompt (enable/disable)	Enabling this feature causes the system to display a message before loading options ROMs.
	Remote Wakeup Boot Source	Enables you to specify which wakeup boot source device to remove.
	After Power Loss	In the event of an AC power loss, this option determines what the computer's behavior should be when power is restored. Options are <b>Off</b> (stay off), <b>On</b> (turn on immediately), and <b>Previous State</b> (if the computer was on when power was lost, turn on immediately; if it was off, stay off).
	POST Delay (in seconds)	Setting this option to a non-zero value adds a delay during POST, which can be necessary for certain add-in peripherals that respond slowly or violate specifications. For instance, disk drives are supposed to spin within 15 seconds, but some older drives might take longer. Options are None, 5, 10, 15, 20.
	Setup Browse Mode	Enables viewing Setup Options without entering Setup password. <b>Enables you to</b> view Setup in read-only mode if you do not enter the Setup password. <b>Disables</b> blocks Setup entirely if you do not enter the Setup password.
	BIOS Power-On	Allows you to disable or specify a weekday and time for BIOS power-on.
	Limit CPUID Maximum value to 3 (enable/disable)	This option tells the processors not to report their full capabilities using the CPUID instruction. Useful for legacy systems.
	Onboard Devices	This selects the legacy devices' interrupt (IRQ), Direct Memory Access (DMA) channel, and I/O range. It can also disable the devices. The values are strictly valid for boot time only—a plug-and-play operating system can change them. Windows XP and Linux will not modify these values under default settings. To hide a device from the operating system, see Security/Device Security.
	Serial Port	Enables you to set I/O and interrupt (IRQ) for the device.
	Parallel Port	Enables you to set I/O, interrupt (IRQ), and DMA channel for the device.
	Diskette Controller	Enables you to set I/O, interrupt (IRQ), and DMA channel for the device.

**Table 3-1** Computer Setup (F10) Utility menu descriptions (continued)

Heading	Option	Description
Chipset/ Memory	PCI SERR# Generation (enable/disable)	Disables PCI SERR# generation for ill-behaved PCI add-in cards (that can generate SERR# spuriously).
	PCI VGA Palette Snooping (enable/disable)	Enables PCI VGA Palette Snooping. This option is kept for compatibility purposes.
	MCH Error Handling	Sets which signal to use on serious MCH (North Bridge) errors. <b>SMI</b> is handled by the BIOS and causes a reboot. <b>NMI</b> and <b>Machine-Check Error</b> are handled by the operating system and cause a crash.
Device Options	Num Lock State at Power-On	Sets the Num Lock state after POST. The operating system can change this state, also.
	S5 Wake on LAN (enable/disable)	Sets the network to wake the system from shutdown (ACPI S5). When set to Disable, system power consumption is reduced to match FEMP guidelines.
	Unique Sleep State Blink Rates	Assigns different LED blink patterns for S1 and S3. (The LED is off for S4 and S5.)
	Monitor Tracking (enable/disable)	Enabling this option allows the ROM to save the monitor asset tracking information such as the serial number and model.
	NIC PXE Option ROM Download (enable/disable)	<b>Disabling this option prevents</b> booting from this device, but more option ROM space is available for other devices.
	SAS Option ROM Download (enable/disable)	Enables or disables downloading embedded SAS option ROM.
	SATA RAID Option ROM Download (enable/disable)	<b>Disabling this option prevents</b> booting this device, but more option ROM space is available for other devices.
	SAS Latency Timer	Sets the latency timer on the SAS controller.
Fast Delayed Transaction Timer	Enables you to set Discard Transaction Timer to "short delay." This might improve performance issues with certain PCI devices. Do not enable this setting unless instructed to do so by the PCI device supplier.	
Slot Options	Slot Options apply to these slot types: <ul style="list-style-type: none"><li>• Slot 1 — PCI Express x16</li><li>• Slot 2 — PCI Express x8(4)</li><li>• Slot 3 — PCI Express x16 (4)</li><li>• Slot 4 — PCI Express x8 (4)</li></ul>	

**Table 3-1** Computer Setup (F10) Utility menu descriptions (continued)

Heading	Option	Description
		<ul style="list-style-type: none"><li>• Slot 5 — PCI 32/33</li><li>• Slot 6 — PCI 32/33</li></ul>
		For PCI Express slots, the available option is <b>Option ROM Download</b> .
		For PCI-X slots, the available options are <b>Speed</b> , <b>Option ROM Download</b> , and <b>Latency Timer</b> .
		For PCI slots, the available options are <b>Option ROM Download</b> and <b>Latency Timer</b> .
		* Available on select models.
		** These options should be used by advanced users only.

## Desktop management

HP Client Management Solutions (available for download from <http://www.hp.com/go/easydeploy>) provides standards-based solutions for managing and controlling workstations in a networked environment. This section summarizes the capabilities and features of the key components of desktop management:

- Initial configuration and deployment
- Remote system installation
- Updating and managing software
- ROM flash
- Asset tracking and security
- Fault notification and recovery



---

**NOTE** Support for specific features described in this guide might vary by model or software version.

---

### Initial configuration and deployment

The workstation comes with a preinstalled system software image. After a brief software “unbundling” process, the workstation is ready to use.

You might prefer to replace the preinstalled software image with a customized set of system and application software. Several methods are available for deploying a customized software image, including:

- Installing additional software applications after unbundling the preinstalled software image
- Using a disk cloning process to copy the contents from one hard drive to another

The best deployment method depends on your information technology environment and processes. The PC Deployment section of the HP Lifecycle Solutions website (<http://whp-sp-orig.extweb.hp.com/country/us/en/solutions.html>) provides information to help you select the best deployment method.

The Restore Plus! CD, ROM-based setup, and ACPI hardware provide further assistance with recovery of system software, configuration management and troubleshooting, and power management.

### Remote system installation

Remote system installation enables you to start and set up your system using the software and configuration information located on a network server. This feature is usually used as a system setup and configuration tool and can be used for the following tasks:

- Deploying a software image on one or more new PCs
- Formatting a hard drive
- Installing application software or drivers
- Updating the operating system, application software, or drivers

To initiate a remote system installation, press **F12** when the **F12=Network Service Boot** message appears in the lower-right corner of the HP logo screen. Follow the on-screen instructions to continue

the process. The default boot order is a BIOS configuration setting that can be changed to always attempt to PXE boot.

HP and Altiris have partnered to provide tools designed to make the task of corporate PC deployment and management easier and less time-consuming, ultimately lowering the total cost of ownership and making HP PCs the most manageable client PCs in the enterprise environment.

## Updating and managing software

HP provides several tools for managing and updating software on desktops and workstations—HP Client Manager Software, Altiris Client Management Solutions, System Software Manager, Proactive Change Notification, and Subscriber's Choice.

### HP Client Manager Software

HP Client Manager Software (HP CMS) assists HP customers in managing the hardware aspects of their client workstations with features that include:

- Detailed views of hardware inventory for asset management
- PC health check monitoring and diagnostics
- Proactive notification of changes in the hardware environment
- Web-accessible reporting of business-critical details such as machines with thermal warnings, memory alerts, and more
- Remote updating of system software such as device drivers and ROM BIOS
- Remote changing of boot order
- Configuring the system BIOS settings

For more information on the HP Client Manager, see <http://h18000.www1.hp.com/im/prodinfo.html>.

### Altiris Client Management Solutions

HP and Altiris have partnered to provide comprehensive, tightly integrated systems management solutions to reduce the cost of owning HP client PCs. HP Client Manager Software is the foundation for additional Altiris Client Management Solutions that address:

- Inventory and asset management
  - Software license compliance
  - PC tracking and reporting
  - Lease contract and fixing asset tracking
- Deployment and migration
  - Microsoft Windows XP Professional or Home Edition migration
  - System deployment
  - Personality migrations

- Help desk and problem resolution
  - Managing help desk tickets
  - Remote troubleshooting
  - Remote problem resolution
  - Client disaster recovery
- Software and operations management
  - Ongoing desktop management
  - HP system software deployment
  - Application self-healing

See <http://h18000.www1.hp.com/im/prodinfo.html> for more information about:

- How HP Client Manager Software works
- Which solutions are compatible with your operating system
- How to download a fully-functional, 30-day evaluation version of the Altiris solutions

## System Software Manager

System Software Manager (SSM) is a utility that enables you to update system-level software on multiple systems simultaneously. When executed on a PC client system, SSM detects both hardware and software versions, and then updates the appropriate software from a central repository, also known as a file store. Driver versions that are supported by SSM are denoted with a special icon on the software, the driver download website, and on the Support Software CD. To download the utility or to obtain more information on SSM, see <http://www.hp.com/go/ssm>.

## Proactive Change Notification

The Proactive Change Notification program uses the Subscriber's Choice website to proactively and automatically:

- Send you Proactive Change Notification (PCN) e-mails informing you of hardware and software changes to most commercial workstations and servers, up to 60 days in advance
- Send you e-mails containing customer bulletins, customer advisories, customer notes, security bulletins, and driver alerts for most commercial workstations and servers

You can create your own profile to ensure that you only receive the information relevant to a specific IT environment. To learn more about the Proactive Change Notification program and create a custom profile, see <http://www.hp.com/go/pcn>.

## Subscriber's Choice

Subscriber's Choice is a client-based service from HP. Based on your profile, HP will supply you with personalized product tips, feature articles, and driver and support alerts and notifications. Subscriber's Choice Driver and Support Alerts/Notifications will deliver e-mails notifying you that the information you subscribed to in your profile is available for review and retrieval. To learn more about Subscriber's Choice and create a custom profile, see <http://www.hp.com/go/pcn>.

## ROM flash

The workstation comes with a programmable flash ROM. By establishing a setup password in the Computer Setup (F10) Utility, you can protect the ROM from being unintentionally updated or overwritten. This is important to ensure the operating integrity of the workstation. Should you need or want to upgrade the ROM, you can:

- Order an upgraded ROMPaq diskette from HP.
- Download the latest ROMPaq images from HP driver and support page, <http://www.hp.com/support/files>.



---

**NOTE** For maximum ROM protection, be sure to establish a setup password. The setup password prevents unauthorized ROM upgrades. System Software Manager enables you to set the setup password on one or more PCs simultaneously. For more information, visit <http://www.hp.com/go/ssm>

---

## Remote ROM Flash

Remote ROM Flash allows the system administrator to safely upgrade the ROM on remote HP workstations directly from the centralized network management console, resulting in a consistent deployment of and greater control over HP PC ROM images over the network. It also results in greater productivity and lower total cost of ownership.

The workstation must be powered on, or turned on through Remote Wakeup, to use Remote ROM Flash.

For more information on Remote ROM Flash, see the HP Client Manager Software or System Software Manager sections at <http://h18000.www1.hp.com/im/prodinfo.html>.

## HPQFlash

The HPQFlash utility is used to locally update or restore the system ROM on individual PCs through a Windows operating system.

For more information on HPQFlash, see <http://www.hp.com/support/files> and enter the name of the workstation when prompted.

## FailSafe Boot Block ROM

The FailSafe Boot Block ROM allows for system recovery in the unlikely event of a ROM flash failure, for example, if a power failure were to occur during a ROM upgrade. The Boot Block is a flash-protected section of the ROM that checks for a valid system ROM flash when power to the system is connected.

- If the system ROM is valid, the system starts normally.
- If the system ROM fails the validation check, the FailSafe Boot Block ROM provides enough support to start the system from a ROMPaq diskette, which will program the system ROM with a valid image.



---

**NOTE** Some models also support recovery from a ROMPaq CD. ISO ROMPaq images are included with selected models in the downloadable ROM softpaqs.

---

When the boot block detects an invalid system ROM, the System Power LED blinks red eight times, one every second, followed by a two-second pause. Also, eight simultaneous beeps will be heard. A Boot Block recovery mode message is displayed on the screen (some models).

To recover the system after it enters Boot Block recovery mode:

1. If there is a diskette in the diskette drive or a CD in the CD drive, remove the diskette and CD and power off the system.
2. Insert a ROMPaq diskette into the diskette drive or, if permitted on this workstation, insert a ROMPaq CD into the CD drive. USB media such as an HP DriveKey can also be used.
3. Power on the workstation.

If no ROMPaq diskette or ROMPaq CD is found, you will be prompted to insert one and restart the workstation.

If a setup password has been established, the Caps Lock light will illuminate and you will be prompted to enter the password.

4. Enter the setup password.

If the system successfully starts from the diskette and successfully reprograms the ROM, then the three keyboard lights will illuminate. A rising tone series of beeps also signals successful completion.

5. Remove the diskette or CD and power off the system.
6. Restart the workstation.

The following table lists the various keyboard light combinations used by the Boot Block ROM (when a PS/2 keyboard is attached to the workstation) and explains the meaning and action associated with each combination.

**Table 3-2** Keyboard light combinations used by boot black ROM

FailSafe Boot Block mode	Keyboard LED activity*	State/Message
Num Lock	On	ROMPaq diskette or ROMPaq CD not present, is bad, or drive not ready.
Caps Lock	On	Enter password.
Num, Caps, Scroll Lock	Flash on in sequence, one at a time—N,C, SL	Keyboard locked in network mode.
Num, Caps, Scroll Lock	On	Boot Block ROM Flash successful. Reboot the system..

\*Diagnostic lights do not flash on USB keyboards.

## Replicating the setup

The following procedures enable you to easily copy one setup configuration to other workstations of the same model for faster, more consistent configuration of multiple workstations.



**NOTE** Both procedures require a diskette drive or a USB device such as an HP Drive Key.

To collect and replicate BIOS settings on multiple computers, use System Software Manager or HP Client Manager Software. For more information, see <http://www.hp.com/go/easydeploy>.



## Copying to a single workstation



**CAUTION** A setup configuration is model-specific. File system corruption can result if source and target workstations are not the same model. For example, do not copy the setup configuration from an HP xw6200 Workstation to an HP xw6400 Workstation.

1. Select a setup configuration to copy, and reboot the workstation.
2. As soon as the workstation powers on, press and hold the **F10** key until you enter the Computer Setup (F10) Utility. Press **Enter** to bypass the title screen, if necessary.



**NOTE** If you do not press the **F10** key at the appropriate time, you must restart the workstation and press and hold the **F10** key again to access the utility.

If you are using a PS/2 keyboard, you may see a Keyboard Error message—disregard it.

3. If you are using a diskette or other storage device, insert it now. If not, proceed.
4. Click **File>Replicated Setup>Save to Removable Media**. Follow the instructions on the screen to create the configuration diskette.
5. Power off the workstation to be configured and insert the configuration diskette.
6. Power on the workstation to be configured.
7. Press and hold the **F10** key until you enter the Computer Setup (F10) Utility. Press **Enter** to bypass the title screen, if necessary.
8. Click **File>Replicated Setup>Restore from Removable Media**, and follow the instructions on the screen.
9. Restart the workstation when the configuration is complete.

## Copying to multiple workstations



**CAUTION** A setup configuration is model-specific. File system corruption can result if source and target workstations are not the same model. For example, do not copy the setup configuration from an HP xw6200 Workstation to an HP xw6400 Workstation.

This method takes a little longer to prepare the configuration diskette, but copying the configuration to target workstations is significantly faster.



**NOTE** A bootable diskette is required for this procedure. If Windows XP is not available to use to create a bootable diskette, use the method for copying to a single workstation instead (see [Copying to a single workstation on page 39](#))

1. Create a bootable diskette.
2. Select a setup configuration to copy.
3. Restart the workstation.
4. As soon as the workstation powers on, press and hold the **F10** key until you enter the Computer Setup (F10) Utility. Press **Enter** to bypass the title screen, if necessary.



---

**NOTE** If you do not press the **F10** key at the appropriate time, you must restart the workstation and press and hold the **F10** key again to access the utility.

If you are using a PS/2 keyboard, you might see a Keyboard Error message—disregard it.

---

5. If you are using a diskette or other storage device, insert it now.
6. Click **File>Replicated Setup>Save to Removable Media**. Follow the instructions on the screen to create the configuration diskette.
7. Download a BIOS utility for replicating setup (repset.exe) and copy it onto the configuration diskette. To obtain this utility, go to <http://www.hp.com/support/files> and enter the model number of the workstation.
8. On the configuration diskette, create an autoexec.bat file containing the following command:  
**repset.exe cpqsetup.txt.**
9. Power off the workstation to be configured. Insert the configuration diskette, and power on the workstation. The configuration utility runs automatically.
10. Restart the workstation when the configuration is complete.

## Dual-State Power Button

With ACPI enabled, the power button can function either as an on/off switch or as a button. The feature does not completely turn off power, but instead causes the workstation to enter a low-power standby state. This allows you to power down without closing applications and to return to the same operational state without any data loss.

To change the power button configuration:

1. Click **Start**, and select **Control Panel>Power Options**.
2. In **Power Options Properties**, click the **Advanced** tab.
3. In the **Power Button** section, select **Hibernate**. (Hibernate must be enabled in the Hibernate tab.)

After configuring the power button to function as a button, press the power button to put the system in a very low power state. Press the button again to bring the system out of the very low power state to full power status. To completely turn off all power to the system, press and hold the power button for four seconds.



---

**CAUTION** Do not use the power button to power off the workstation unless the system is not responding; turning off the power without operating system interaction could cause damage to or loss of data on the hard drive.

---

## HP support website

HP engineers rigorously test and debug software developed by HP and third-party suppliers and develop operating system specific support software to ensure performance, compatibility, and reliability for HP workstations.

When making the transition to new or revised operating systems, you must implement the support software designed for that operating system. If you plan to run a version of Microsoft Windows that is different from the version included with the workstation, you must install corresponding device drivers and utilities to ensure that all features are supported and functioning properly.

HP has made the task of locating, accessing, evaluating, and installing the latest support software easier. You can download the software from <http://www.hp.com/support>.

This website contains the latest device drivers, utilities, and flashable ROM images needed to run the latest Microsoft Windows operating system on the HP workstation.

## Building blocks and partners

HP management solutions integrate with other systems management applications and are based on industry standards, such as:

- Web-Based Enterprise Management (WBEM)
- Windows Management Interface (WMI)
- Wake-on-LAN technology
- ACPI
- SMBIOS
- PXE support
- Alert Standard Format

## Asset tracking and security

Asset tracking features incorporated into the workstation provide key asset tracking data that can be managed using HP Systems Insight Manager, HP Client Manager Software, or other system management applications. Seamless, automatic integration between asset tracking features and these products enables you to choose the management tool that is best suited to the environment and to leverage the investment in existing tools.

HP also offers several solutions for controlling access to valuable components and information. ProtectTools Embedded Security, if installed, prevents unauthorized access to data and checks system integrity and authenticates third-party users attempting system access. Security features such as ProtectTools and the Hood Sensor (Smart Cover Sensor) help prevent unauthorized access to the internal components of the workstation. By disabling parallel, serial, or USB ports or by disabling removable media boot capability, you can protect valuable data assets. Memory Change and Hood Sensor (Smart Cover Sensor) alerts can be automatically forwarded to system management applications to deliver proactive notification of tampering with a workstation's internal components.



---

**NOTE** ProtectTools, the Hood Sensor (Smart Cover Sensor), and the Hood Lock (Smart Cover Lock) are available as options on select systems.

---

Use the following utilities to manage security settings on the HP workstation:

- Locally, using the Computer Setup (F10) Utility.
- Remotely, using HP Client Manager Software or System Software Manager. This software enables the secure, consistent deployment and control of security settings from a simple command line utility.

The following table and sections refer to managing security features of the workstation locally through the Computer Setup (F10) Utility.

**Table 3-3** Security Features Overview

Feature	Purpose	How it is established
Removable Media Boot Control	Prevents booting from the removable media drives.	From the Computer Setup (F10) Utility Menu.
Serial, Parallel, USB, or Infrared Interface Control	Prevents transfer of data through the integrated serial, parallel, USB, or infrared interface.	From the Computer Setup (F10) Utility menu.
Power-On Password	Prevents use of the workstation until the password is entered. This can apply to both initial system startup and restarts.	From the Computer Setup (F10) Utility menu.
Setup Password	Prevents reconfiguration of the workstation (use of the Setup Utilities) until the password is entered.	From the Computer Setup (F10) Utility menu.
Network Server Mode	Provides unique security features for workstations being used as servers.	From the Computer Setup (F10) Utility menu.
Ownership Tag	Displays ownership information, as defined by the system administrator, during system startup (protected by setup password).	From the Computer Setup (F10) Utility menu.
Kensington Cable Lock Provision	Prevents entire system theft only.	Install a Kensington cable lock to secure the workstation to a fixed object.
Padlock Loop	Prevents the side access panel from being removed. This loop can also be used to secure the unit to a fixed object.	Install a padlock.
Access Panel Key Lock (Standard)	Prevents the removal of the access panel and all internal components, including optical and floppy drives.	Lock the access panel.
Hood Sensor (Optional)	Notifies a local or remote user when the chassis access panel has been opened.	Install an intrusion sensor.
Universal Chassis Clamp Lock (Optional)	The version without a cable discourages access panel removal and prevents theft of I/O devices. The version with a cable additionally prevents entire system theft and allows multiple systems to be secured with a single cable.	Install a chassis clamp lock.
Hood Lock (Smart cover lock) (Optional)	Prevents removal of the access panel and all internal components including optical and floppy drives. Eliminates the need for a physical key by enabling password-protected locking and unlocking by a local or remote user.	Install a hood lock.

**NOTE:** For more information about the Computer Setup (F10) Utility, see [Computer Setup \(F10\) Utility menu on page 26](#).

## Password security

The power-on password prevents unauthorized use of the workstation by requiring entry of a password to access applications or data each time the workstation is powered on or restarted. The setup password specifically prevents unauthorized access to the Computer Setup (F10) Utility and can also be used as an override to the power-on password. That is, when prompted for the power-on password, entering the setup password instead will allow access to the workstation.

You can establish a network-wide setup password to enable the system administrator to log in to all network systems to perform maintenance without having to know the power-on password.



---

**NOTE** System Software Manager and HP Client Manager Software allow remote management of Setup Passwords and other BIOS settings in a networked environment. For more information, see <http://www.hp.com/go/easydeploy>.

---

### Establishing a setup password using the Computer Setup (F10) Utility

Establishing a setup password through the Computer Setup (F10) Utility prevents reconfiguration of the workstation (via use of the Computer Setup (F10) Utility) until the password is entered.

To establish a setup password using workstation setup:

1. Power on or restart the workstation.
2. As soon as the computer is powered on, press and hold the **F10** key until you enter the Computer Setup (F10) Utility. Press **Enter** to bypass the title screen, if necessary.



---

**NOTE** If you do not press the **F10** key at the appropriate time, you must restart the workstation and press and hold the **F10** key again to access the utility.

---

If you are using a PS/2 keyboard, you might see a Keyboard Error message—disregard it.

---

3. Select **Security>Setup Password** and follow the on-screen instructions.
4. Before exiting, select **File>Save Changes and Exit**.

### Establishing a power-on password using workstation setup

Establishing a power-on password through the Computer Setup (F10) Utility prevents access to the workstation when power is connected, unless the password is entered. When a power-on password is set, the Computer Setup (F10) Utility presents Password Options under the Security menu. The password options include Network Server Mode and Password Prompt on Warm Boot.

When Network Server Mode is disabled, the password must be entered each time the workstation is powered on when the key icon appears on the monitor. When Password Prompt on Warm Boot is enabled, the password must also be entered each time the workstation is rebooted. When Network Server Mode is enabled, the password prompt is not presented during POST, but any attached PS/2 keyboard remains locked until you enter the power-on password.

To enable Network Server Mode, a power-on password must be set. The option is available under **Advanced>Password Options**. This option enables the system to boot without asking for the power-on password, but the keyboard and mouse are locked until you enter it. The keyboard LEDs rotate constantly when the system is in locked mode.

To establish a power-on password through workstation setup:

1. Power on or restart the workstation.
2. As soon as the computer is powered on, press and hold the **F10** key until you enter the Computer Setup (F10) Utility. Press **Enter** to bypass the title screen, if necessary.



---

**NOTE** If you do not press the **F10** key at the appropriate time, you must restart the workstation and press and hold the **F10** key again to access the utility.

---

If you are using a PS/2 keyboard, you might see a Keyboard Error message—disregard it.

---

3. Select **Security>Power-On Password** and follow the onscreen instructions.
4. Before exiting, select **File>Save Changes** and **Exit**.

### Entering a power-on password

1. Restart the workstation.
2. When the key icon appears on the monitor, enter the current password, and press **Enter**.



---

**NOTE** Type carefully. For security reasons, the characters you enter do not appear on the screen.

---

If you enter the password incorrectly, a broken key icon appears. Try again. After three unsuccessful tries, you must restart the workstation before you can continue.

### Entering a Setup Password

If a setup password has been established on the workstation, you will be prompted to enter it each time you run the Computer Setup (F10) Utility.

To enter a setup password:

1. Restart the workstation.
2. As soon as the workstation is powered on, press and hold the **F10** key until you enter the Computer Setup (F10) Utility. Press **Enter** to bypass the title screen, if necessary.



---

**NOTE** If you do not press the **F10** key at the appropriate time, you must restart the workstation and press and hold the **F10** key again to access the utility.

---

If you are using a PS/2 keyboard, you might see a Keyboard Error message—disregard it.

---

3. When the key icon appears on the monitor, enter the setup password, and press **Enter**.



---

**NOTE** Type carefully. For security reasons, the characters you enter do not appear on the screen.

---

If you enter the password incorrectly, a broken key icon appears. Try again. After three unsuccessful tries, you must restart the workstation before you can continue.

### Changing a power-on or setup password

1. Restart the workstation.
2. To change the Setup password, as soon as the workstation is turned on, press and hold the **F10** key until you enter the Computer Setup (F10) Utility. Press **Enter** to bypass the title screen, if necessary.



---

**NOTE** If you do not press **F10** at the appropriate time, you must restart the workstation and press and hold the **F10** key again to access the utility.

---

If you are using a PS/2 keyboard, you might see a Keyboard Error message—disregard it.

---

- When the key icon appears, enter the current password, a slash (/) or alternate delimiter character, your new password, another slash (/) or alternate delimiter character, and your new password again as shown: **current password/new password/new password**



**NOTE** Type carefully. For security reasons, the characters you enter do not appear on the screen.

- Press **Enter**.

The new password takes effect the next time you turn on the workstation.



**NOTE** See a [National keyboard delimiter characters on page 45](#) for information about the alternate delimiter characters. The power-on password and setup password can also be changed using the Security options in the Computer Setup (F10) Utility.

## Deleting a power-on or setup password

- Power on or restart the workstation.
- To delete the power-on password, go to step 3.

To delete the Setup Password, as soon as the workstation is powered on, press and hold the **F10** key until you enter the Computer Setup (F10) Utility. Press **Enter** to bypass the title screen, if necessary.



**NOTE** If you do not press the **F10** key at the appropriate time, you must restart the computer and press and hold the **F10** key again to access the utility.

Use the appropriate operating system shutdown process. To delete the setup password, run the Computer Setup (F10) Utility.

- When the key icon appears, enter your current password followed by a slash (/) or alternate delimiter character as shown: **current password/**
- Press **Enter**.



**NOTE** See the [National keyboard delimiter characters on page 45](#) section for information about the alternate delimiter characters. The power-on password and setup password can also be changed using the Security options in the Computer Setup (F10) Utility.

## National keyboard delimiter characters

Each keyboard is designed to meet country-specific requirements. The syntax and keys that you use for changing or deleting your password depend on the keyboard that came with your workstation.

**Table 3-4** National keyboard delimiter characters

Language	Delimiter	Language	Delimiter	Language	Delimiter
Arabic	/	Greek	-	Russian	/
Belgian	=	Hebrew	.	Slovakian	-
BHCSY*	-	Hungarian	-	Spanish	-
Brazilian	/	Italian	-	Swedish/Finnish	/

**Table 3-4** National keyboard delimiter characters (continued)

Language	Delimiter	Language	Delimiter	Language	Delimiter
Chinese	/	Japanese	/	Swiss	-
Czech	-	Korean	/	Taiwanese	/
Danish	-	Latin American	-	Thai	/
French	!	Norwegian	-	Turkish	.
French Canadian	é	Polish	-	U.K. English	/
German	-	Portuguese	-	U.S. English	/

**NOTE:** \* For Bosnia-Herzegovina, Croatia, Slovenia, and Yugoslavia.

## Clearing passwords

If you forget your password, you cannot access the workstation. See the section on resetting the password jumper for instructions on clearing passwords.

## Hood sensor (smart cover sensor)

The optional hood sensor is a combination of hardware and software technology that can alert you when the workstation side access panel has been removed if the sensor has been properly configured in the Computer Setup Utility. There are three levels of protection, as described in the following table.

**Table 3-5** Hood Sensor Protection Levels

Level	Setting	Description
Level 0	Disabled	Hood sensor is disabled (default).
Level 1	Notify User	When the workstation restarts, the screen displays a message indicating that the workstation side access panel has been removed.
Level 2	Setup Password	When the workstation is restarted, the screen displays a message indicating that the workstation side access panel has been removed. You must enter the setup password to continue.

These settings can be changed using the Computer Setup (F10) Utility.

## Setting the hood sensor protection level

1. Power on or restart the workstation.
2. As soon as the workstation is powered on, press and hold the **F10** key until you enter the Computer Setup (F10) Utility. Press **Enter** to bypass the title screen, if necessary.



**NOTE** If you do not press the **F10** key at the appropriate time, you must restart the computer and press and hold the **F10** key again to access the utility.

If you are using a PS/2 keyboard, you might see a Keyboard Error message—disregard it.

3. Select **Security>Smart Cover>Cover Removal Sensor**, and follow the on-screen instructions.
4. Before exiting, click **File>Save Changes and Exit**.



## Hood lock (Smart cover lock) (optional)

When installed, the optional hood lock (Smart cover lock) can prevent unauthorized access to the internal components.



---

**CAUTION** For maximum cover lock security, be sure to establish a setup password. The setup password prevents unauthorized access to the Computer Setup utility.

---

### Locking the hood lock (Smart cover lock):

1. Power on or restart the workstation.
2. As soon as the workstation is powered on, press and hold the **F10** key until you enter Computer Setup. Press **Enter** to bypass the title screen, if necessary.



---

**NOTE** If you do not press the **F10** key at the appropriate time, you must restart the workstation and press and hold the **F10** key again to access the utility.

If you are using a PS/2 keyboard, you might see a Keyboard Error message—disregard it.

---

3. Select **Security>Smart Cover>Cover Lock>Lock**.
4. Select **Fire>Save Changes and Exit**.

### Unlocking the hood lock (Smart cover lock):

1. Turn on or restart the workstation.
2. As soon as the workstation is powered on, press and hold the **F10** key until you enter Computer Setup. Press **Enter** to bypass the title screen, if necessary.



---

**NOTE** If you do not press the **F10** key at the appropriate time, you must restart the workstation and press and hold the **F10** key again to access the utility.

If you are using a PS/2 keyboard, you might see a Keyboard Error message—disregard it.

---

3. Select **Security>Smart Cover>Cover Lock>Unlock**.
4. Select **Fire>Save Changes and Exit**.

### Using the FailSafe key

If you enable the optional hood lock (Smart cover lock) and cannot enter your password to disable the lock, you will need a FailSafe Key to open the workstation side access panel. You will need the key in any of the following circumstances:

- Power outage
- Startup failure
- PC component failure (such as processor or power supply)
- Forgotten password



---

**CAUTION** The side access panel FailSafe Key is a specialized tool available from HP. Be prepared; order this key before you need one.

---

To obtain the FailSafe Key, complete any one of the following tasks:

- Contact your authorized HP reseller or service provider.
- Access the HP website (<http://www.hp.com>) for ordering information.
- Access the Contact HP Worldwide website (<http://welcome.hp.com/country/us/en/wwcontact.html>) for contact information.

### Clearing Passwords

If you forget your password, you cannot access the workstation. See the section on resetting the password jumper in the appendix.

### Cable lock provision (optional)

The rear panel of the chassis can accommodate a cable lock accessory that allows the workstation to be physically secured to a work area.

### Security lock (optional)

The security lock prevents entire system theft and discourages access panel removal.

### Universal chassis clamp lock (optional)

The version without a cable discourages side access panel removal and prevents theft of I/O devices. The version with a cable also prevents entire system theft and allows multiple systems to be secured with a single cable.

### Hood lock (Smart cover lock) (optional)

Prevents removal of the access panel and all internal components including optical and diskette drives. This lock eliminates the need for a physical key by enabling password-protected locking and locking by a local or a remote user.

### Hood sensor (Smart cover sensor) (optional)

This sensor is set in the Computer Setup utility. You can set this to notify a user if the access panel has been removed.

### Access panel key lock

This lock prevents removal of the access panel and all internal components. The key is shipped on the rear of the workstation.

## Fault notification and recovery

Fault notification and recovery features combine innovative hardware and software technology to prevent the loss of critical data and minimize unplanned downtime.

If the workstation is connected to a network managed by HP Client Manager Software, the computer sends a fault notice to the network management application. With HP Client Manager Software, you can also remotely schedule diagnostics to automatically run on all managed PCs and create a summary report of failed tests.

## Drive Protection System

The Drive Protection System(DPS) is a diagnostic tool built into the hard drives that is installed in select HP workstations. the DPS is designed to help diagnose problems that might result in unwarranted hard drive replacement.

When HP workstations are built, each installed hard drive is tested using the DPS, and a permanent record of key information is written onto the drive. Each time the DPS is run, test results are written to the hard drive. The service provider can use this information to help diagnose conditions that caused you to run the DPS software.

## ECC fault prediction and prefailure warranty

When the workstation encounters an excessive number of error checking and correcting (ECC) memory errors, the workstation displays a Local Alert message. This message contains detailed information about the errant memory module, enabling you to take action before you experience non-correctable memory errors. The Prefailure Warranty for ECC memory modules enables you to replace these modules, free of charge, before the modules actually fail. ECC memory modules are optional on selected HP systems.

## Thermal sensor

There are multiple sensors on your workstation:

- One per processor
- One on power supply
- Two for the system board
- Some hard drives

The processor thermal sensor is a hardware and software feature that tracks the internal temperature of the CPU. When combined with HP Client Manager Software, this features notifies the network administrator when the normal range is exceeded.

The processor temperature sensors monitor CPU temperature. In the unlikely event that the processor temperature gets too hot, the processor clock automatically begins to throttle. If the temperature does not go down, then the system eventually shuts down.



# 4 Removal and replacement procedures

This chapter describes removal and replacement procedures of most internal components.

- [Service considerations on page 52](#)
- [Customer Self-Repair on page 56](#)
- [Predisassembly procedures on page 57](#)
- [System board components on page 58](#)
- [Removal and replacement of components on page 60](#)

## Service considerations

The following sections discuss service considerations that should be reviewed and practiced before removing and replacing any system components.



**WARNING!** When lifting or moving the workstation, do not use the front bezel as a handle or lifting point. Lifting the workstation from the front bezel or lifting it incorrectly can cause the unit to fall and harm you and damage the workstation. To properly and safely lift the workstation, lift it from the bottom of the unit.

## Read cautions, warnings, and safety precautions

For your safety, review the cautions, warnings, and safety precautions before accessing the workstation components. Also, review the *Safety and Regulatory Guide* that came with your workstation for more information.

## Electrostatic discharge information

A sudden discharge of static electricity from your finger or other conductor can destroy static-sensitive devices or microcircuitry. Often the spark is neither felt nor heard, but damage occurs. An electronic device exposed to electrostatic discharge (ESD) might not appear to be affected at all and can function normally for a while, but it has been degraded in the internal layers, reducing its life expectancy.

Networks built into many integrated circuits provide some protection, but in many cases, the discharge contains enough power to alter device parameters or melt silicon junctions.

## Generating static

The following table shows that different activities generate different amounts of static electricity. Static electricity increases as humidity decreases.

**Table 4-1** Static electricity

Event	Relative humidity		
	55%	40%	10%
Walking across carpet	7,500 V	15,000 V	35,000 V
Walking across vinyl floor	3,000 V	5,000 V	12,000 V
Motions of bench worker	400 V	800 V	6,000 V
Removing bubble pack from PCB	7,000 V	20,000 V	26,500 V
Packing PCBs in foam-lined box	5,000 V	11,000 V	21,000 V

NOTE: 700 volts can degrade a product.

## Preventing electrostatic damage to equipment

Many electronic components are sensitive to ESD. Circuitry design and structure determine the degree of sensitivity. The following packaging and grounding precautions are necessary to prevent damage to electric components and accessories.

- Transport products in static-safe containers, such as tubes, bags, or boxes, to avoid hand contact.
- Protect all electrostatic parts and assemblies with conductive or approved containers or packaging.
- Keep electrostatic-sensitive parts in their containers until they arrive at static-free stations.
- Place items on a grounded surface before removing them from their containers.
- When handling or touching a sensitive component or assembly, ground yourself by touching the chassis.
- Avoid contact with pins, leads, or circuitry.
- Place reusable electrostatic-sensitive parts from assemblies in protective packaging or conductive foam.

## Personal grounding methods and equipment

Use the following equipment to prevent static electricity damage to equipment:

- Wrist straps are flexible straps with a maximum of one megohm  $\pm$  10% resistance in the ground cords. To provide a proper ground, wear the strap against bare skin. The ground cord must be connected and fit snugly into the banana plug connector on the grounding mat or workstation.
- Heel straps, toe straps, and boot straps can be used at standing workstations and are compatible with most types of shoes or boots. On conductive floors or dissipative floor mats, use them on both feet with a maximum of one-megohm  $\pm$  10% resistance between the operator and ground.

**Table 4-2** Static shielding protection levels

Method	Voltage
Antistatic plastic	1,500
Carbon-loaded plastic	7,500
Metallized laminate	15,000

## Grounding the work area

To prevent static damage at the work area:

- Cover the work surface with approved static-dissipative material. Provide a wrist strap connected to the work surface and properly grounded tools and equipment.
- Use static-dissipative mats, foot straps, or air ionizers to give added protection.
- Handle electrostatic sensitive components, parts, and assemblies by the case or PCB laminate. Handle them only at static-free work areas.
- Disconnect power and input signals before inserting and removing connectors or test equipment
- Use fixtures made of static-safe materials when fixtures must directly contact dissipative surfaces.

- Keep work area free of nonconductive materials, such as ordinary plastic assembly aids and Styrofoam.
- Use field service tools, such as cutters, screwdrivers, and vacuums, that are conductive.

## Recommended materials and equipment

Materials and equipment that are recommended for use in preventing static electricity include:

- Antistatic tape
- Antistatic smocks, aprons, or sleeve protectors
- Conductive bins and other assembly or soldering aids
- Conductive foam
- Conductive tabletop workstations with ground cord of one-megohm  $\pm$  10% resistance
- Static-dissipative table or floor mats with hard tie to ground
- Field service kits
- Static awareness labels
- Wrist straps and footwear straps providing one-megohm  $\pm$  10% resistance
- Material handling packages
- Conductive plastic bags
- Conductive plastic tubes
- Conductive tote boxes
- Opaque shielding bags
- Transparent metallized shielding bags
- Transparent shielding tubes

## Tools and software requirements

- Torx T-15 screwdriver or flathead screwdriver
- Diagnostics software

## Screws

The screws used in the workstation are not interchangeable. They might have standard or metric threads and might be of different lengths. If an incorrect screw is used during the reassembly process, it can damage the unit. HP strongly recommends that all screws removed during disassembly be kept with the removed part, and then returned to their proper locations.

## Special handling of components

The following components require special handling when servicing the workstation.



## Cables and connectors

Cables must be handled with care to avoid damage. Apply only the tension required to seat or unseat the cables during insertion or removal from the connector. Handle cables by the connector or pull strap whenever possible. In all cases, avoid bending or twisting the cables, and be sure that the cables are routed in such a way that they cannot be caught or snagged by parts being removed or replaced.



---

**CAUTION** When servicing this workstation, be sure that cables are placed in their proper location during the reassembly process. Improper cable placement can damage the workstation.

---

## Hard drives

Handle hard drives as delicate, precision components, avoiding all physical shock and vibration. This guideline applies to failed drives as well as replacement spares.

- If a drive must be mailed, place the drive in a bubble-pack mailer or other suitable protective packaging and label the package “Fragile: Handle With Care.”
- Do not remove hard drives from the shipping package for storage. Keep hard drives in their protective packaging until they are actually mounted in the workstation.
- Avoid dropping drives from any height onto any surface.
- If you are inserting or removing a hard drive, power off the workstation. Do not remove a hard drive while the workstation is on or in standby mode.
- Before handling a drive, be sure that you are discharged of static electricity. While handling a drive, avoid touching the connector. For more information about preventing electrostatic damage, see [Electrostatic discharge information on page 52](#).
- Do not use excessive force when inserting a drive.
- Avoid exposing a hard drive to liquids, temperature extremes, or products that have magnetic fields such as monitors or speakers.

## Lithium coin cell battery

The battery that comes with the workstation provides power to the real-time clock and has a minimum lifetime of about three years.

For instructions on battery removal and replacement, see the [Battery on page 82](#).



---

**WARNING!** This workstation contains a lithium battery. There is a risk of fire and chemical burn if the battery is handled improperly. Do not disassemble, crush, puncture, short external contacts, dispose in water or fire, or expose it to temperatures higher than 140°F (60°C).

---



---

**NOTE** Batteries, battery packs, and accumulators should not be disposed of together with general household waste.

---

## Customer Self-Repair

Customer Self-Repair enables you to obtain replacement parts and install them yourself on your workstation. The following table indicates which workstation components are customer-serviceable. See <http://www.hp.com/go/selfrepair/> for more information.

## Predisassembly procedures

Perform the following steps before servicing the workstation:

1. Close any open software applications.
2. Remove any diskettes or CDs from the workstation.
3. Shut down the operating system.
4. Power off the workstation and any peripheral devices that are connected to it.
5. Remove or disengage any security devices that prohibit opening the workstation.
6. Disconnect the power cord from the electrical outlet and then from the workstation.
7. Disconnect all peripheral device cables from the workstation.

# System board components

The following image shows the system board connectors and sockets on the HP xw6400 Workstation.

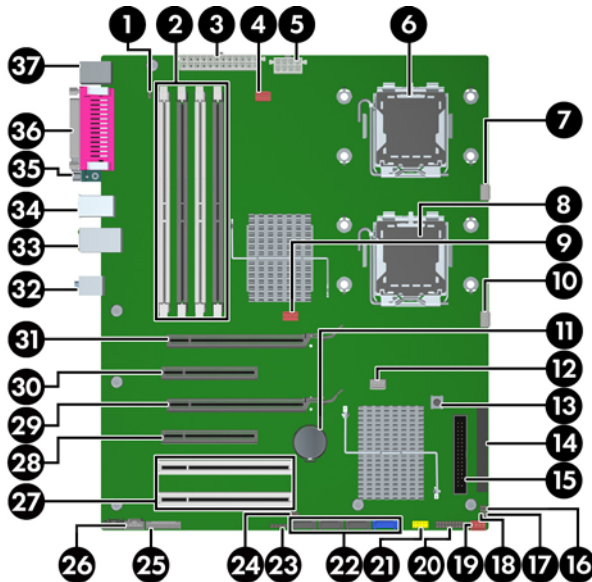

**Figure 4-1** System board identification

**Table 4-3** System board components

No.	Component	No.	Component	No.	Component
1	Solenoid hood lock	14	Optical drives	27	PCI 32/33
2	Memory sockets	15	Diskette drive	28	PCI Express x8 (4)*
3	Main power	16	HDD LED	29	PCI Express x16 (4)*
4	Upper rear chassis fan	17	Password jumper	30	PCI Express x8 (4)*
5	Auxiliary power	18	Crisis recovery jumper	31	PCI Express x16
6	Processor 1	19	Front chassis fan	32	Audio
7	Processor 1 fan	20	Front control panel	33	Network/USB
8	Processor 2	21	Front USB	34	USB
9	Lower rear chassis fan	22	Serial ATA (SATA)	35	Serial
10	Processor 2 fan	23	Internal USB	36	Parallel
11	Battery	24	Boot block jumper	37	Keyboard/Mouse
12	Memory fan	25	Front audio		
13	Clear CMOS button	26	Auxiliary audio		

\* Electrically x4 bandwidth

## System board architecture

The following image shows the HP xw6400 Workstation block diagram.

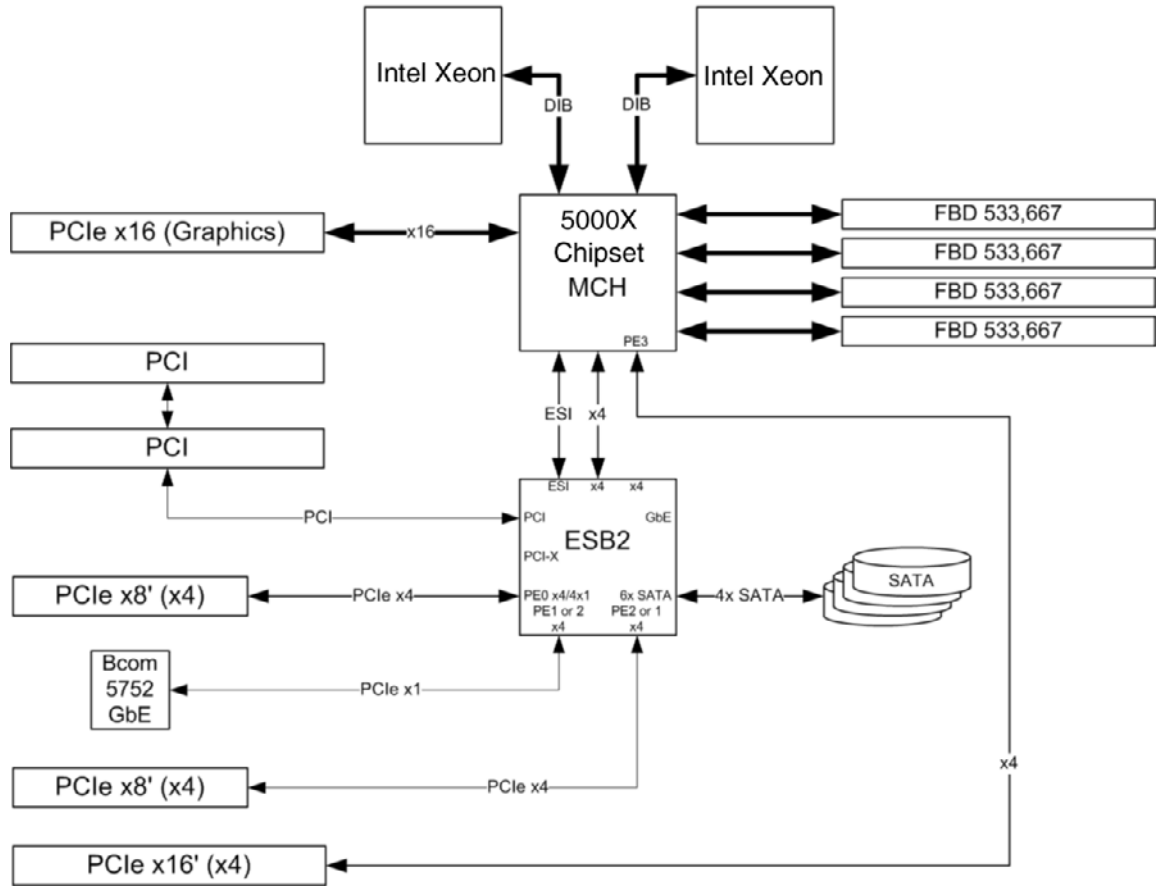

Figure 4-2 System board block diagram

## Removal and replacement of components

This section discusses the procedures necessary to remove and install various hardware components on your workstation. Review the safety and precautions and the [Service considerations on page 52](#), as well as the *Safety and Regulatory Information*, before servicing or upgrading your system.

1. Read all safety information and precautions.
2. Locate and clear a suitable work area.
3. Shut down the system and remove power from the unit.
4. Gather your tools.
5. Service your unit.
6. Restore power to your unit.

### Disassembly order

Use the following table to determine the sequence in which to remove the major components.

Predisassembly ( <a href="#">Predisassembly procedures on page 57</a> )
Locks ( <a href="#">Security lock (optional) on page 61</a> )
Side access panel ( <a href="#">Side access panel on page 63</a> )
Hood sensor ( <a href="#">Hood sensor (Smart cover sensor) on page 66</a> )
Top cover <a href="#">Top cover on page 65</a>
Front bezel ( <a href="#">Front Bezel on page 64</a> )
Front panel I/O device assembly ( <a href="#">Front panel I/O device assembly on page 68</a> )
Power button and front speaker ( <a href="#">Power button assembly and system speaker on page 68</a> )
Optical drive ( <a href="#">Optical drive on page 84</a> )
Diskette drive ( <a href="#">Diskette drive (optional) on page 86</a> )
Bezel blanks ( <a href="#">Bezel blanks on page 65</a> )

Power supply ( <a href="#">Power supply on page 71</a> )
System fan ( <a href="#">System fan assembly on page 71</a> )
Memory ( <a href="#">Memory on page 72</a> )
Front fan removal (optional) ( <a href="#">Front PCI card guide and fan removal (optional) on page 81</a> )
Battery ( <a href="#">Battery on page 82</a> )
Hard drive ( <a href="#">Hard drive on page 88</a> )
CPU heatsink ( <a href="#">Removing the CPU heatsink on page 91</a> )
Processor ( <a href="#">Removing the processor on page 94</a> )
PCI retainer ( <a href="#">PCI retainer on page 75</a> )
PCI or PCI express card ( <a href="#">PCI removal on page 77</a> )
CPU heatsink ( <a href="#">Removing the CPU heatsink on page 91</a> )
Processor ( <a href="#">Removing the processor on page 94</a> )
System board ( <a href="#">System board on page 96</a> )

## Security lock (optional)

If a security padlock is installed, remove it before servicing the unit. To remove the padlock, unlock it and slide it out of the padlock loop as shown in the following image.



**Figure 4-3** Removing the security lock

### **Cable lock (optional)**

If a cable lock is installed, remove it before servicing the unit. To remove the cable lock, unlock it and pull it out of the cable lock slot as shown in the following image.



**Figure 4-4** Removing the cable lock

### **Universal chassis clamp lock (optional)**

If a universal chassis clamp lock is installed, remove it before servicing the unit.



To remove the lock:

1. Unlock the device and remove the locking mechanism.



2. Remove the screw attaching the lock to the chassis.



## Side access panel

Before accessing the internal components of the workstation, the side access panel must be removed.

To remove the side access panel:



**WARNING!** Before removing the workstation side access panel, be sure that the workstation is powered off and that the power cord is disconnected from the electrical outlet.

1. Disconnect power from the system  
([Predisassembly procedures on page 57](#)).
2. If necessary, unlock the side access panel. The keys are on the rear panel. Also, unlock any other locks that are present (Cable lock or Padlock).
3. Pull up on the handle **1** and lift off the cover **2**.

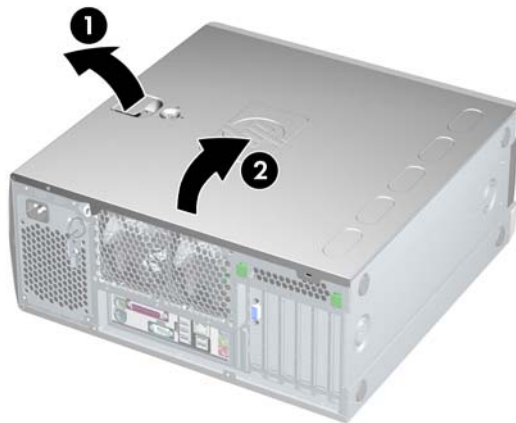
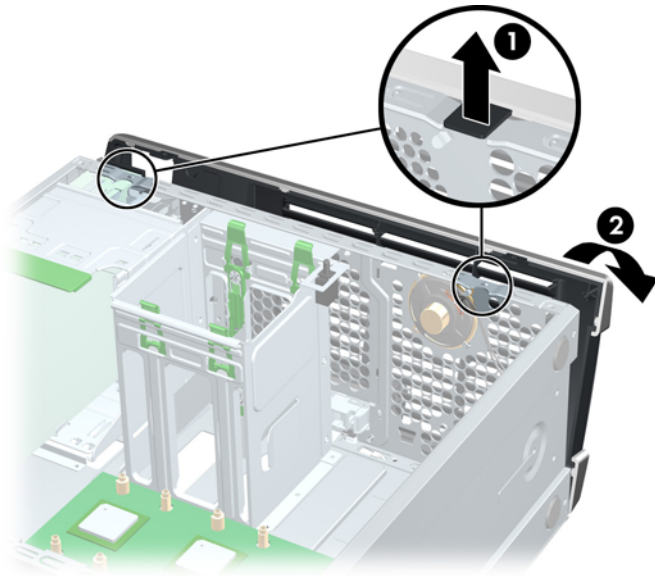

**Figure 4-5** Opening the side access panel

To replace the side access panel, align the bottom groove of the side access panel with the bottom edge of the chassis, rotate the side access panel toward the chassis and press firmly until the latch engages.

## Front Bezel

1. Lift up on the two release snaps **1** located on the front bezel.
2. Rotate the front bezel away **2** from the chassis to remove the bezel.



**Figure 4-6** Opening the front bezel

To replace the front bezel, align front bezel on the bottom and rotate in until it snaps into place.

## Bezel blanks

To remove the bezel blanks:

1. Disconnect power from the system ([Predisassembly procedures on page 57](#)) and remove the front bezel ([Front Bezel on page 64](#))
2. Remove the bezel blanks by squeezing in **1** on the tabs and pushing the bezel blanks out **2**.

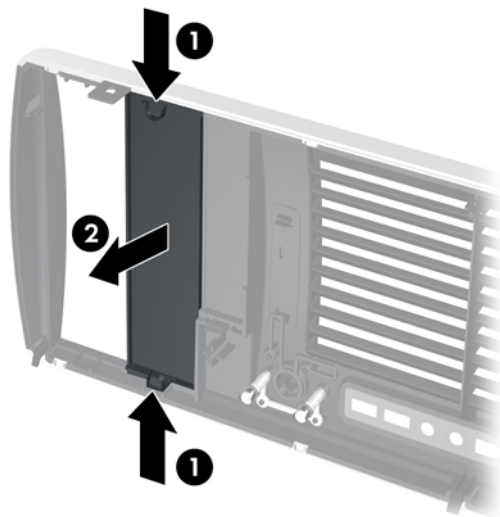

**Figure 4-7** Removing the bezel blanks

## Top cover



**NOTE** It is unnecessary to remove the top cover for most removal or replacement procedures.

To remove the top cover:

1. Disconnect power from the system ([Predisassembly procedures on page 57](#)), remove the side access panel ([Side access panel on page 63](#)), and remove the front bezel ([Front Bezel on page 64](#)).
2. Push a flat screw driver into tab 1 on the rear of the chassis and gently pry the cover upward.
3. Push the top cover toward the rear of the chassis and lift the cover up 2.

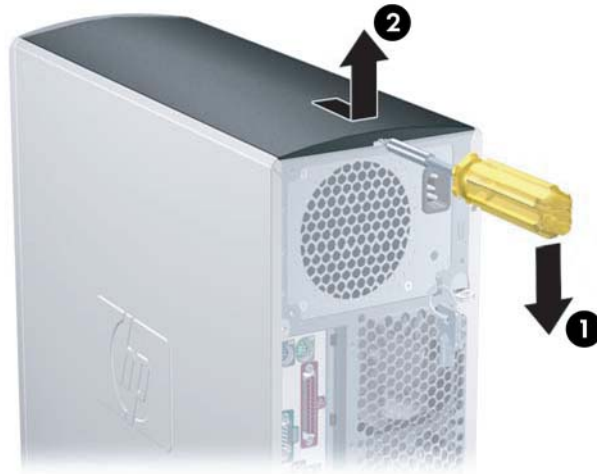
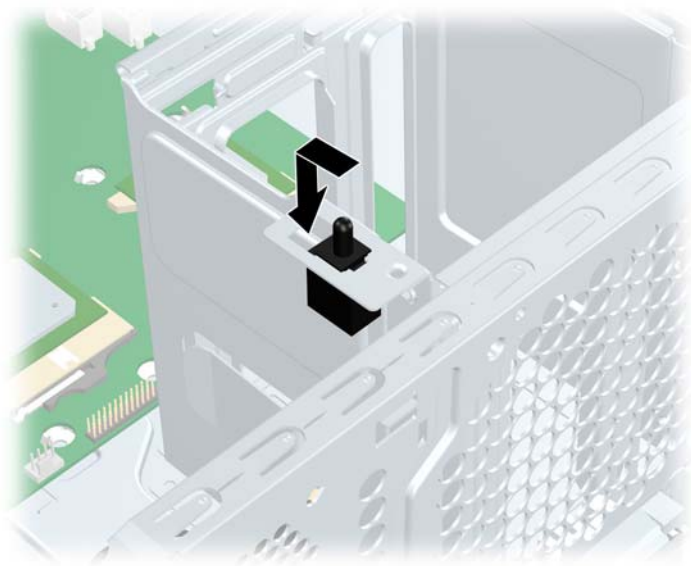

**Figure 4-8** Removing the Top Cover

## Hood sensor (Smart cover sensor)

To remove the hood sensor:

1. Disconnect power from the system ([Predisassembly procedures on page 57](#)) and remove the side access panel ([Side access panel on page 63](#)).
2. Disconnect the white 1x3 hood sensor connector from the in-line connector attached to the front panel harness.
3. Slide the hood sensor forward.
4. Slide the hood sensor forward, push it down, and remove it from the chassis.



**Figure 4-9** Removing the hood sensor

To replace the hood sensor, reverse the previous steps.

## Hood lock (Smart cover lock) (optional)

To remove the hood lock:

1. Disconnect power from the system ([Predisassembly procedures on page 57](#)), remove the side access panel ([Side access panel on page 63](#)), and remove the top cover ([Top cover on page 65](#)).
2. Using the FailSafe key, remove the two tamper-resistant screws that secure the hood lock to the chassis.

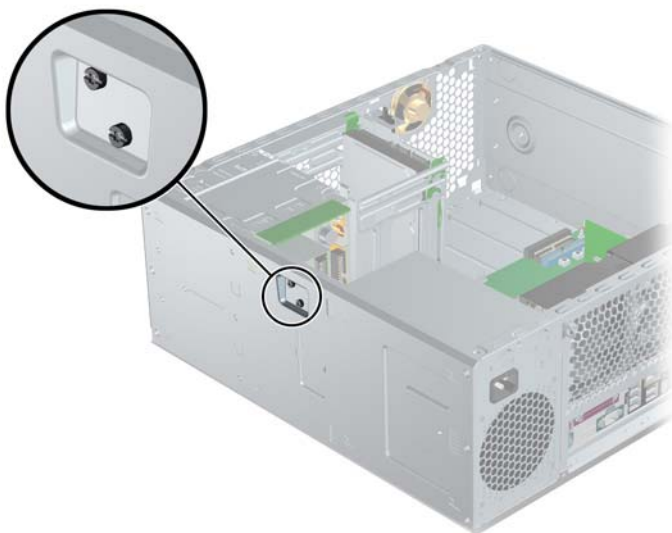

**Figure 4-10** Removing the hood lock

3. Disconnect the hood lock cable from the system board and remove the lock assembly.

To install the hood lock, reverse the previous steps.

## Front panel I/O device assembly

To remove the front panel I/O device assembly:

1. Disconnect power from the system ([Predisassembly procedures on page 57](#)), remove the side access panel ([Side access panel on page 63](#)), and remove the front bezel ([Front Bezel on page 64](#)).
2. Unlatch the plastic snap that secures the cables inside the chassis and disconnect the front panel I/O device assembly cables from the system board.
3. Remove the screws **1** that hold the front panel I/O device assembly and bracket to the chassis and remove the screws **2** that hold the front panel I/O device assembly to the bracket.
4. Pull the front panel I/O device assembly out **3** about 2 inches (5 cm) away from the chassis.
5. Separate the bracket **4** from the front panel I/O device assembly.

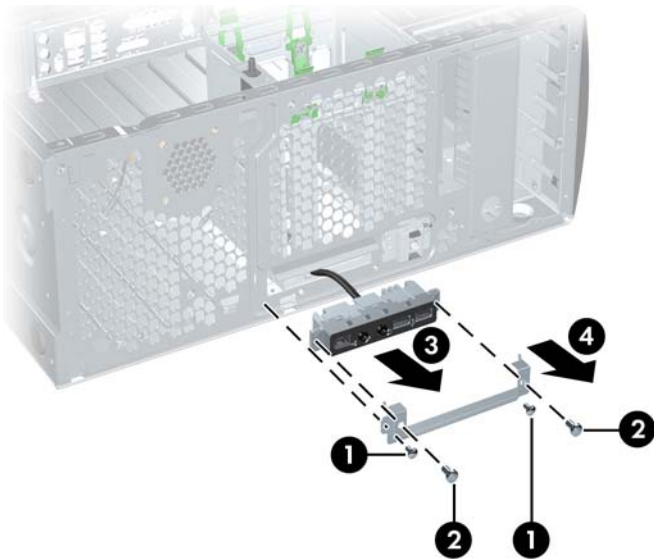

**Figure 4-11** Removing the front panel I/O device assembly

6. Slide the front panel cables through the chassis and out the front of the unit.

To replace the front panel I/O device assembly, reverse the previous steps.

## Power button assembly and system speaker

The power button and the system speaker are part of the same assembly.

To remove the power button:

1. Disconnect power from the system ([Predisassembly procedures on page 57](#)) and remove the side access panel ([Side access panel on page 63](#)). Remove the front bezel ([Front Bezel on page 64](#)) and the front panel I/O device assembly ([Front panel I/O device assembly on page 68](#)).
2. Disconnect the power button assembly cable from the system board.
3. Disconnect the speaker wire and the hood sensor from the in-line connectors on the power button assembly cable.
4. Remove the screw that secures the power button assembly to the chassis.

5. Dislodge the metal clip from the chassis by rocking the power button back and forth. Then slide the power button assembly **2** out from the front of the chassis.
6. Slide the power button assembly out from the front of the chassis.

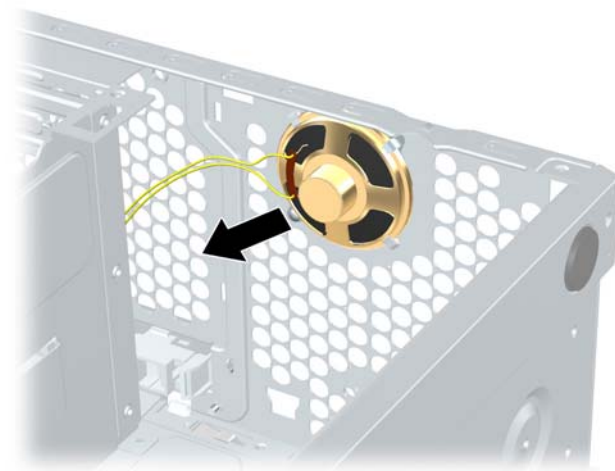

**Figure 4-12** Removing the power button

To replace the power button, reverse the previous steps.

To remove the speaker:

1. Disconnect the speaker cable from the in-line front panel I/O device assembly cable, if you have not already done so.
2. Slide the speaker away from the three flanges and remove it from the chassis.



**Figure 4-13** Removing the speaker

To replace the speaker, reverse the previous steps.

## Memory fan



**CAUTION** HP only ships DIMMs that are electrically and thermally compatible with this product. Because third-party DIMMs might not be compatible, they are not supported by HP.



To remove the memory fan:

1. Disconnect power from the system ([Predisassembly procedures on page 57](#)) and remove the side access panel ([Side access panel on page 63](#)).
2. Grasp the two green touch point tabs **1**, lift up and away **2** from the system fan housing.

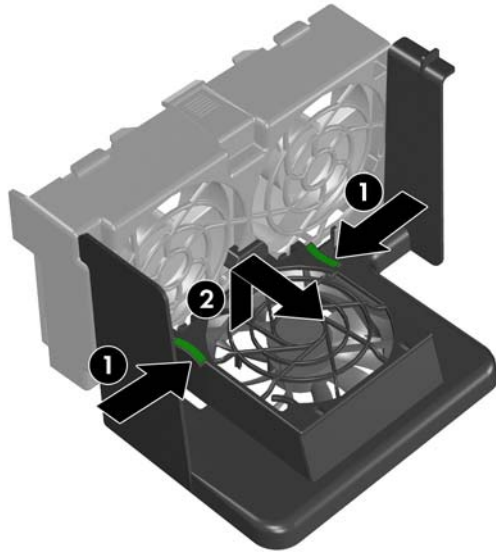

**Figure 4-14** Removing the memory fan

To replace the memory fan:

1. Align the two center and two outer hooks to the circular opening of the system fan housing.
2. Press down on the memory fan housing until it snaps into position.

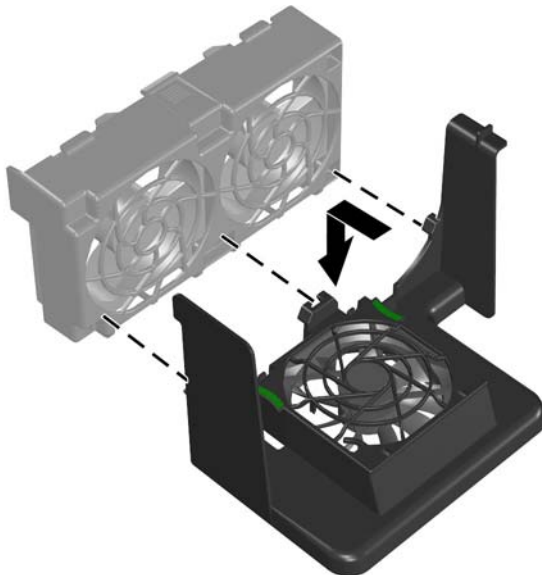

**Figure 4-15** Replacing the memory fan



## System fan assembly

To remove the system fan assembly:

1. Disconnect power from the system ([Predisassembly procedures on page 57](#)), remove the side access panel ([Side access panel on page 63](#)), and remove the memory fan ([Memory fan on page 69](#)).
2. Disconnect the system fan cables from the system board connectors **1**.
3. Press in on the ribbed release snap of the system fan housing **2**, rotate the fan housing down **3**, and lift the unit out of the chassis.

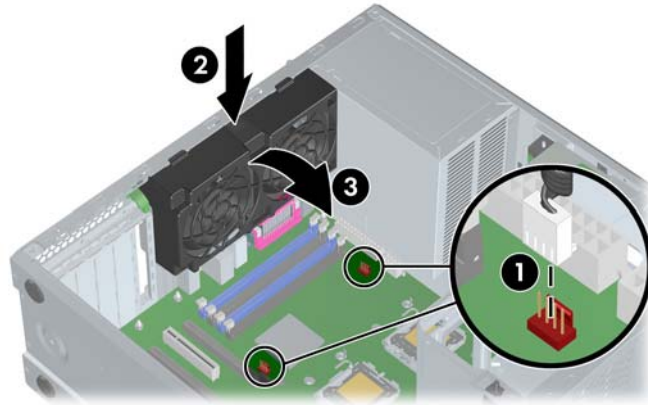

**Figure 4-16** Removing the system fan

To replace a system fan assembly, there are four plastic tabs that must be aligned carefully in corresponding chassis holes and then rotate and snap.



**NOTE** Be sure to also reinstall the memory fan.

## Power supply

1. Disconnect power from the system ([Predisassembly procedures on page 57](#)) and remove the side access panel ([Side access panel on page 63](#)).
2. Disconnect the power supply cables from the system board.



**CAUTION** Be sure you can differentiate which power cable was disconnected from the PCI Express x16 graphics card and which power cable was disconnected from the system board. These two cables have different pin counts and different colors. The PCI Express power cable has a 6-pin black connector, and the system board power cable has an 8-pin white connector. When power is present, you must **never** connect the PCI Express power cable to the system board. If you do so, the system board can be damaged and your warranty voided. To see a picture of the PCI Express cable and where it must be connected, see the [PCI installation on page 79](#).

3. Disconnect all other components connected to the power supply, such as optical drives, diskette drive, hard drives, and select models of add-in cards.
4. Remove the four screws **1** from the back panel.
5. Slide the power supply toward the front **2** and lift up **3** to remove it from the chassis.

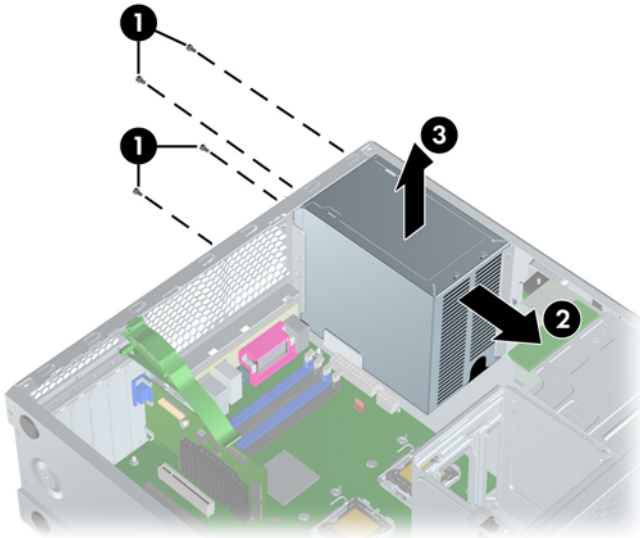

**Figure 4-17** Removing the power supply

To install the power supply, reverse the previous steps.

## Memory

### Memory module requirements

- Use only industry-standard, registered PC2-5300F DIMMs
- Match DIMM pairs by size and type
- No support for unbuffered memory

### Removing memory module

1. Disconnect power from the system ([Predisassembly procedures on page 57](#)), remove the side access panel ([Side access panel on page 63](#)), and remove the memory fan ([Memory fan on page 69](#)).

**CAUTION** To ensure that memory modules are not damaged during removal or installation, power off the workstation and unplug the power cord from the AC power outlet. Wait until the LED on the back of the power supply turns off before removing memory. If you do not unplug the power cord while installing memory, your memory modules might be damaged and the system will not recognize the memory changes.

2. Gently push outward **1** on the socket levers.

3. Lift the DIMM straight up **2** and remove it from the unit.

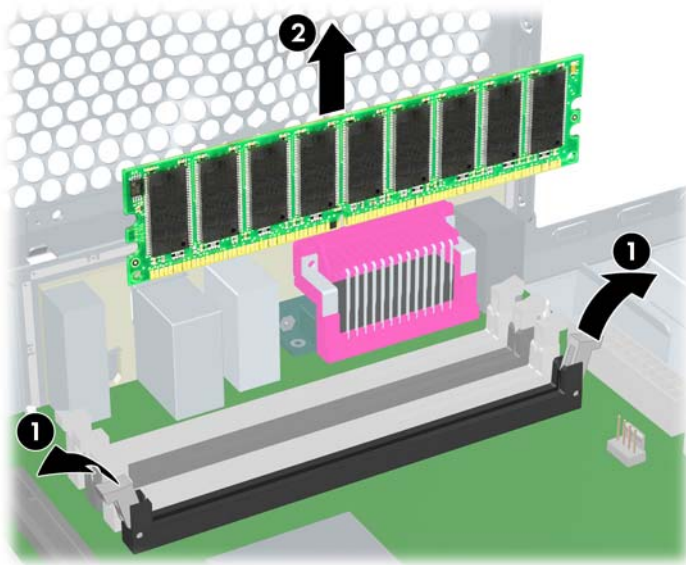

**Figure 4-18** Removing the DIMM



**NOTE** DIMMs and the DIMM sockets are keyed for proper installation. Be sure these guides line up when installing a DIMM.

## Installing memory module



**CAUTION** HP only ships DIMMs that are electrically and thermally compatible with this product. Third-party DIMMs might not be electrically or thermally compatible, so they are not supported by HP.

You must load memory modules in valid configurations:

- If loading only one DIMM, install it in slot 1.
- If loading two DIMMs, install them in slots 1 and 3.
- If loading four DIMMs, install them in all slots.
- Load the memory module pairs in order of size, from smallest to largest.



**Figure 4-19** Identifying the memory slots

The BIOS generates warnings/errors on invalid memory configurations.

- If there is no way to obtain a valid memory configuration by disabling some of the plugged-in memory, the BIOS will halt with a diagnostics 2006 code for memory error (five beeps/blinks).
- If the BIOS can find a valid memory configuration by disabling some of the plugged-in memory, it will do so and will report a warning during POST (“215-mismatched memory”). The system can still be booted in this condition.

## Installing a DIMM

1. Disconnect power from the system ([Pre-disassembly procedures on page 57](#)), remove the side access panel ([Side access panel on page 63](#)), and remove memory fan ([Memory fan on page 69](#)).
2. Gently push outward on the socket levers.
3. Lower the DIMM straight down and be sure the socket levers secure the module into place.
4. Reinstall the memory fan ([Memory fan on page 69](#)).



**NOTE** Ensure that all cables are clear of the fan housing when lowering the memory fan.

## PCI Slots

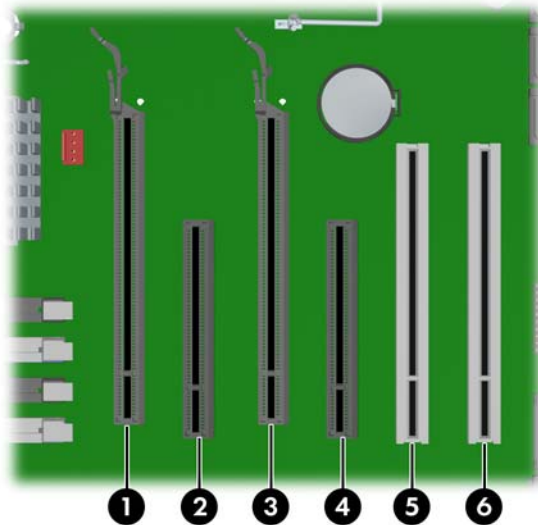

**Figure 4-20** Identifying the PCI slots

**Table 4-4** PCI slots

Slot	Type
1	PCI Express x16
2	PCI Express x8 (4)
3	PCI Express x16 (4)
4	PCI Express x 8 (4)

**Table 4-4** PCI slots (continued)

5	PCI 32/33
6	PCI 32/33

## PCI retainer

For added protection, some cards have PCI retainers installed to prevent movement during shipping.

### Removing PCI retainer

1. Disconnect power from the system ([Predisassembly procedures on page 57](#)) and remove the side access panel ([Side access panel on page 63](#)).
2. For short or tall PCI cards, press in **1** on the ribbed portion of the holder and apply upward pressure on the lower arm **2** and rotate it out of the chassis.

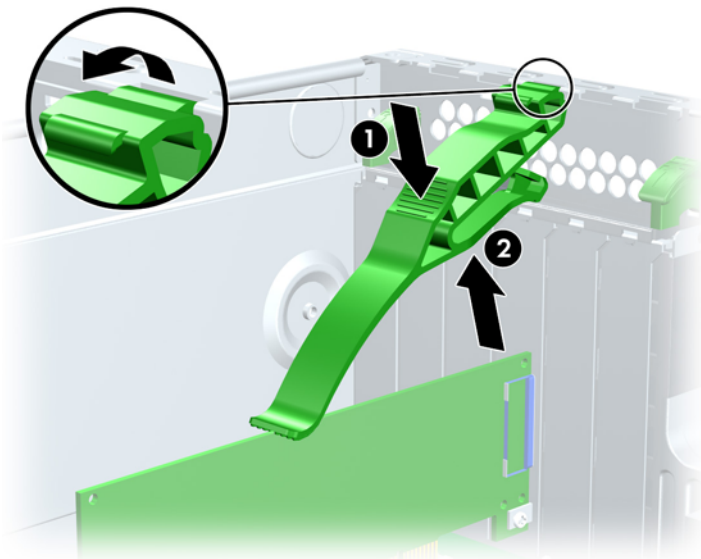

**Figure 4-21** Removing PCI retainer for short card

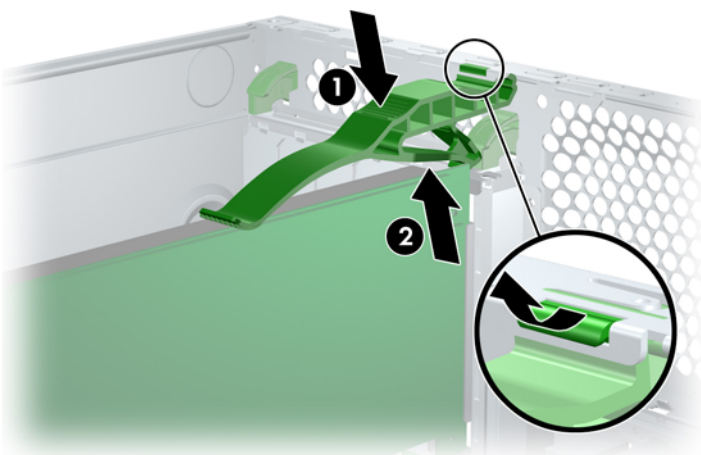

**Figure 4-22** Removing the PCI retainer for tall card

## Installing PCI retainer

1. Disconnect power from the system ([Predisassembly procedures on page 57](#)) and remove the side access panel ([Side access panel on page 63](#)).
2. Attach the PCI retainer. For short PCI cards, attach the hooks of the support arm **1** under the slots on the rear of the chassis, and rotate the card support down. The arm will flex on the card and you lift the front part of the arm **2** onto the chassis.
  - For short PCI cards, attach the lip of the PCI retainer *over* the chassis slot **1** and pull the lower part of the arm over the PCI retention clamp **2**.
  - For tall PCI cards, attach the lip of the PCI retainer *under* the chassis slot **1** and pull the lower part of the arm over the PCI retention clamp **2**.

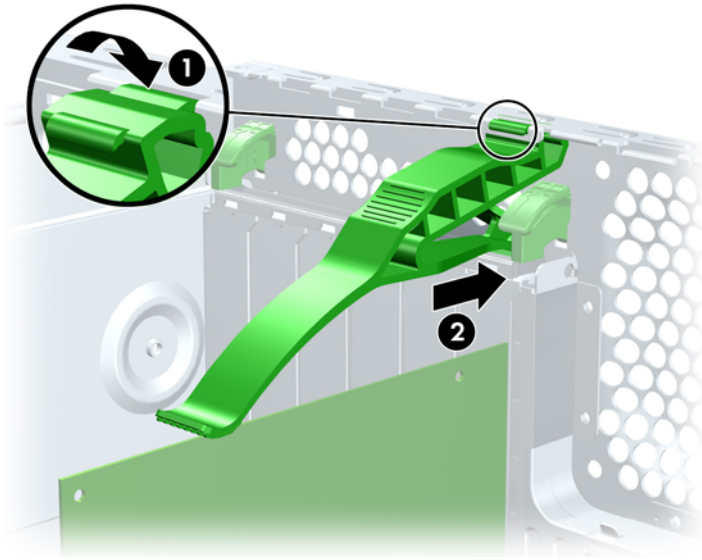

Figure 4-23 Installing PCI retainer on short card

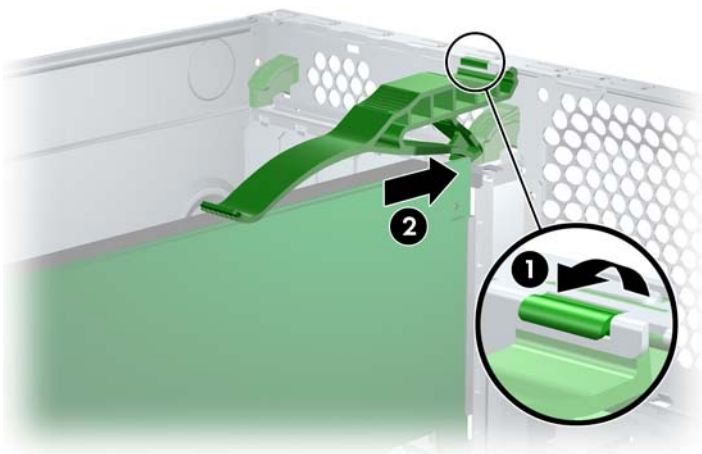

Figure 4-24 Installing the PCI retainer on tall card

## PCI Express

PCI Express is a point-to-point architecture and uses a serial data transmission protocol. A single PCI Express lane consists of four wires and can transmit 250 MB in a single direction or 500 MB in both directions simultaneously. This bandwidth is not affected by what is happening on other PCI Express

buses or legacy PCI/PCI-X buses (provided that total bandwidth can be handled by the CPU and the memory subsystem). The transmission protocol is somewhat similar to that used for a LAN connection and contains error correction and detection, packet addressing, and other network features.

PCI Express improves system attributes. PCI Express enables a low-power, scalable, high-bandwidth communication path with a small number of connections (wires) compared to traditional parallel interfaces (e.g., PCI).

The PCI Express I/O slots can support other PCI Express cards with lesser bus bandwidth than what is physically defined for the slot. Use the following table to determine compatibility.

For example, a PCI Express x8 card does not work in a PCI Express x1 slot, but a PCI Express x1 card works in a PCI Express x8 slot.



**NOTE** Slot 2 and Slot 4: The HP xw6400 Workstation contains two PCI Express x8 slots that support x4 bandwidth. If a PCI Express x8 card is plugged into a PCI Express x8 slot, the card runs at x4 bandwidth.

Slot 3: The HP xw6400 Workstation contains one PCI Express x16 slot that supports x4 bandwidth. If a PCI Express x8 or x16 card is plugged into the PCI Express x8 slot, the card runs at x4 bandwidth. The maximum power for a PCI Express x16 graphics card is 75W.

**Table 4-5** PCI Express compatibility matrix for xw6400

	Slot 1	Slot 2 and Slot 4	Slot 3
	x16 mechanical	x8 mechanical	x16 mechanical
	x16 electrical	x4 electrical	x4 electrical
PCI Express x1 card	Y	Y	Y
PCI Express x4 card	Y	Y	Y
PCI Express x8 card	Y	Y	Y
PCI Express x16 card	Y	N	Y

## PCI removal

1. Disconnect power from the system ([Predisassembly procedures on page 57](#)), remove the side access panel ([Side access panel on page 63](#)), and remove the PCI retainer ([PCI retainer on page 75](#)).
2. Release the PCI retention clamp by first pressing down on the green snaps **1** and rotating the PCI retention clamp upward.
3. For full length PCI cards, disengage the release snap on the front chassis card guide (not illustrated).
4. Lift the PCI card out **2** of the chassis. Store the card in an antistatic bag.



5. Close the PCI retention clamp by rotating the clamp downward and pushing on the two green snaps down from the rear panel of the chassis.

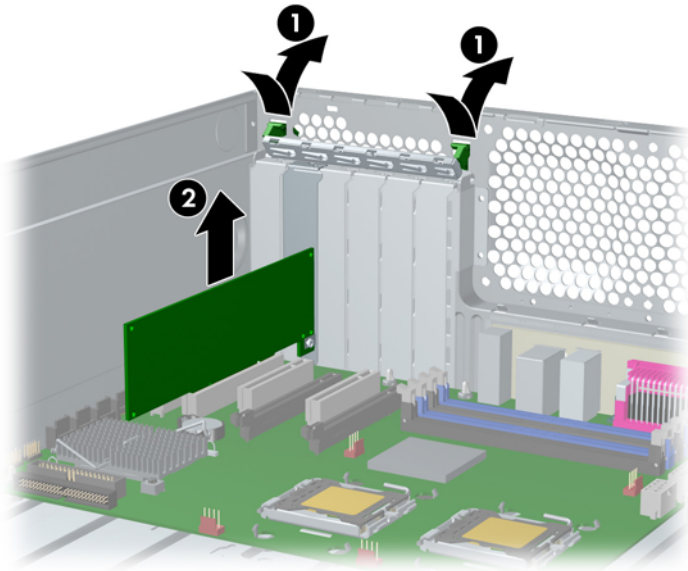

**Figure 4-25** Removing the PCI card

## PCI Express removal

1. Disconnect power from the system ([Predisassembly procedures on page 57](#)), remove the side access panel ([Side access panel on page 63](#)), and remove the PCI retainer ([PCI retainer on page 75](#)).
2. Release the PCI retention clamp by first pressing down on the green snaps **1** and rotating the PCI retention clamp upward.
3. For full length PCI Express cards, disengage the release snap on the front chassis card guide (not illustrated).
4. Remove the auxiliary power supply cable (not illustrated) if required, and move the “hockey stick” lever **2** to release the card and lift it **3** out of the chassis. Store the card in an antistatic bag.



5. Close the PCI retention clamp by rotating the clamp downward and pushing on the two green snaps down from the rear panel of the chassis.

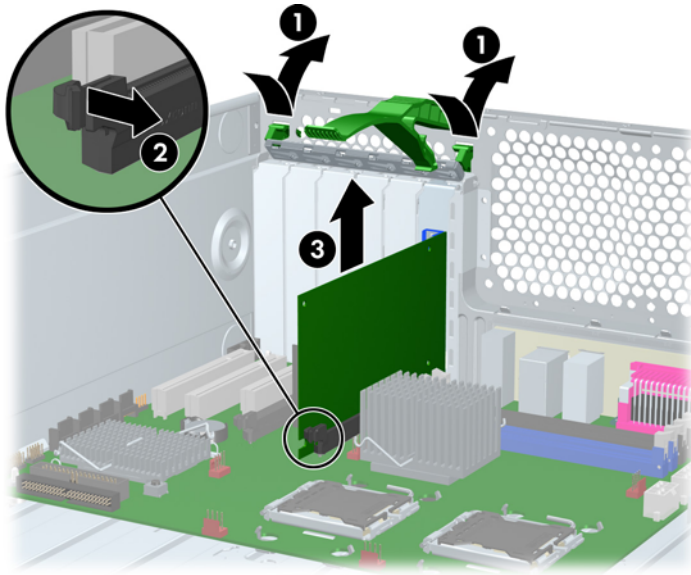

**Figure 4-26** Removing the PCI Express card

## PCI installation

1. Disconnect power from the system ([Predisassembly procedures on page 57](#)) and remove the side access panel ([Side access panel on page 63](#)).
2. Release the PCI retention clamp by first pressing down on the green snaps **1** and rotating the clamp upward.
3. Remove the PCI slot cover **2**.
4. Lower the PCI **3** card into the chassis. Verify that the keyed components of the card align with the socket.
5. Close the PCI retention clamp **4** by rotating the clamp downward and pushing on the two green snaps down from the rear panel of the chassis.

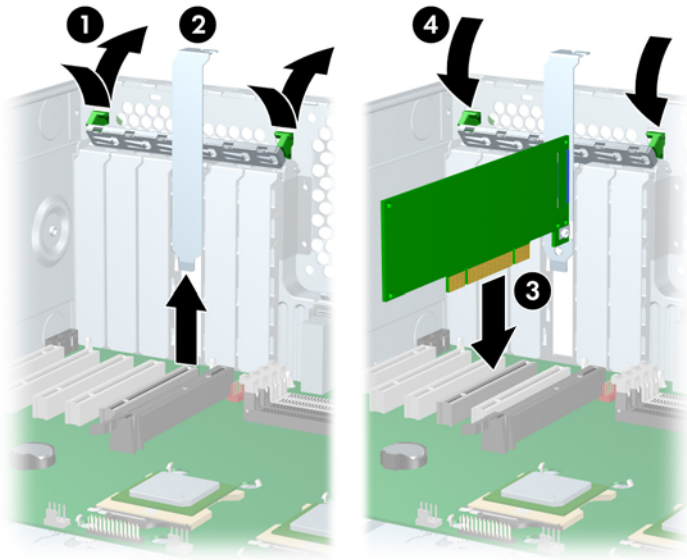

**Figure 4-27** Installing the PCI card

### PCI Express installation

1. Disconnect power from the system ([Predisassembly procedures on page 57](#)) and remove the side access panel ([Side access panel on page 63](#)).
2. Release the PCI retention clamp by first pressing down on the green snaps **1** and rotating the clamp upward.
3. Remove the PCI slot cover **2**.
4. Lower the PCI Express **3** card into the chassis. Verify that the keyed components of the card align with the socket.
5. Close the PCI retention clamp **4** by rotating the clamp downward and pushing on the two green snaps down from the rear panel of the chassis.
6. If installing a PCI Express high-end graphics card, plug in the auxiliary cable **5** from the power supply.

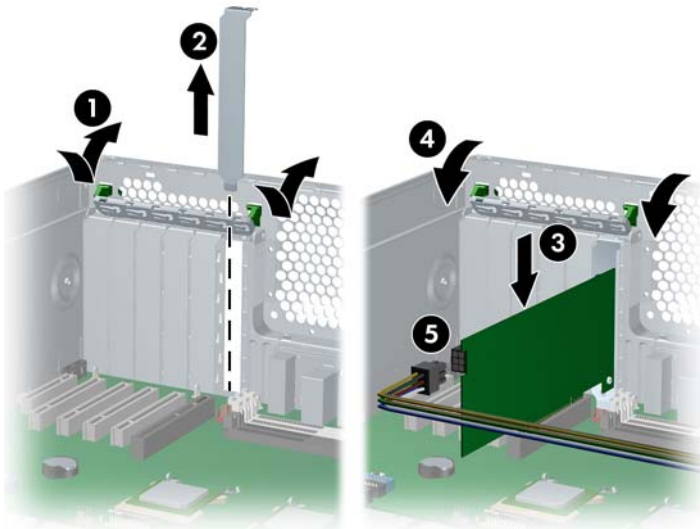

**Figure 4-28** Installing the PCI Express card

## Front PCI card guide and fan removal (optional)



**NOTE** The fan is only used for special configurations, but the card guide is used with all full-length add-in cards.

1. Disconnect power from the system ([Predisassembly procedures on page 57](#)), remove the side access panel ([Side access panel on page 63](#)), and remove the front bezel ([Front Bezel on page 64](#)).
2. Disconnect the fan wire 1 from the connector on the system board.
3. Release the two card guide latches 2 (only one illustrated). Pivot the card guide toward the system board 3, and lift it out of the chassis 4.

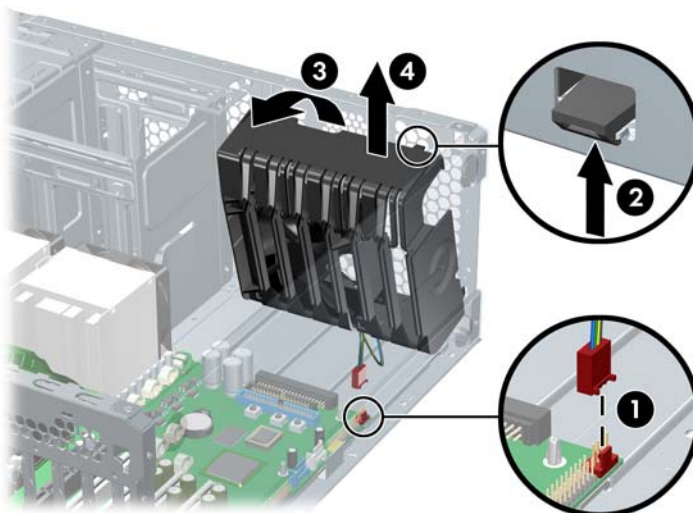

**Figure 4-29** Removing the front fan

4. Remove the fan from the fan housing by applying outward pressure on the card guide while lifting the fan away.

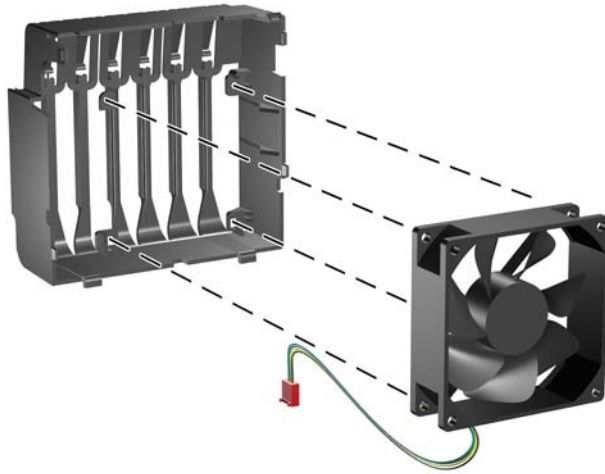

**Figure 4-30** Removing the fan from the card guide

To install the front fan:

1. Place the fan in the card guide with the fan label facing into the card guide.



---

**NOTE** Ensure that the fan blows toward the rear of the of the chassis.

---

2. Place the fan wire through the slot in the card guide.
3. Snap the fan into the card guide.

## Battery

The battery that comes with the workstation provides power to the real-time clock and has a minimum lifetime of about three years.



---

**WARNING!** This workstation contains a lithium battery. There is a risk of fire and chemical burn if the battery is handled improperly. Do not disassemble, crush, puncture, short external contacts, dispose in water or fire, or expose it to temperatures higher than 140°F (60°C).

---



---

**CAUTION** Before removing the battery, be sure your CMOS settings are backed up as all CMOS settings are lost when the battery is removed. To back up the CMOS settings, use Computer Setup and run the Save to Diskette option from the File menu.

---



---

**NOTE** Batteries, battery packs, and accumulators should not be disposed of together with general household waste.

---

1. Disconnect power from the system ([Predisassembly procedures on page 57](#)) and remove the side access panel ([Side access panel on page 63](#)).
2. On the system board, press on the release tab of the battery holder.
3. Rotate the battery enough to get beyond the latch and lift it straight up.

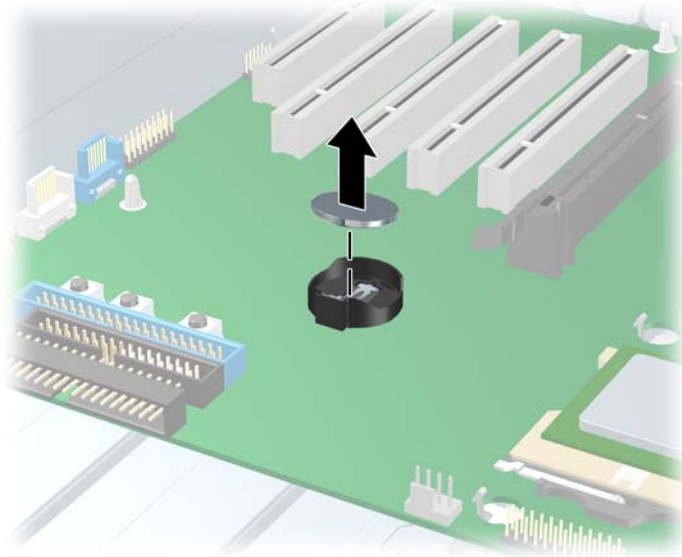

**Figure 4-31** Removing the battery

To install the battery, confirm the polarity (pos-neg), position battery edge under plastic housing tabs, and press down until the metal snaps engage.

## Power connections to drives

For help in identifying power cables, refer to the following information. Route or tie cables so that there is no possible way for them to interfere with the CPU heatsink fans.



---

**CAUTION** Be sure you can differentiate which power cable connects to the PCI Express x16 graphics card and which power cable connects to the system board. These two cables have different pin counts and different colors. The PCI Express power cable has a 6-pin black connector, and the system board power cable has an 8-pin white connector. When power is present, you must **never** connect the PCI Express power cable to the system board. If you do so, the system board might be damaged and your warranty voided.

---

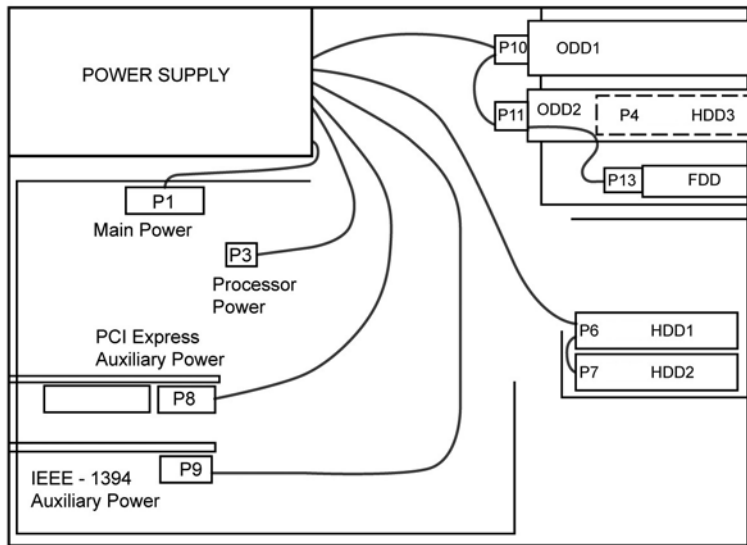

**Figure 4-32** Identifying the correct power connections for a typical configuration

## Optical drive

To remove an optical drive:

1. Disconnect power from the system ([Predisassembly procedures on page 57](#)), remove the side access panel ([Side access panel on page 63](#)) and remove the front bezel ([Front Bezel on page 64](#)).
2. Disconnect the audio **1**, data **2**, and power **3** cables from the drive. The connector colors might be different than illustrated.



**NOTE** The audio cable is only required for Linux-based systems.

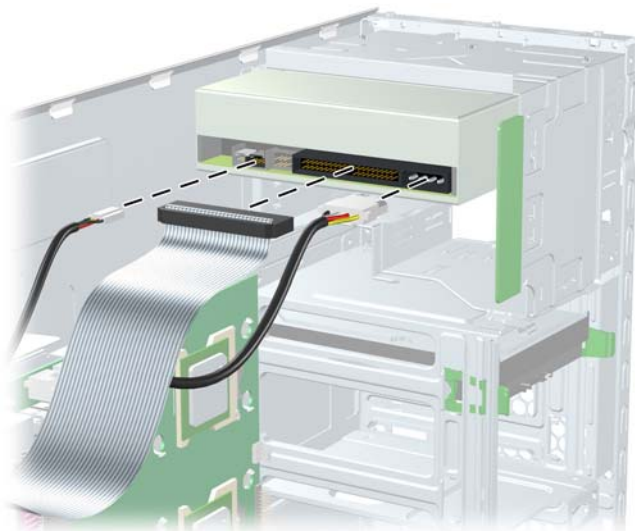

**Figure 4-33** Disconnecting the cables from the optical drive

3. Lift the green drive-lock release lever 1 and gently slide the drive 2 out of the chassis.



**Figure 4-34** Removing the optical drive from the chassis

To :

1. Lift the green drive-lock release lever while sliding the optical drive into the bay. When the optical drive is partially inserted, release the drive-lock release lever and slide the drive inward until the drive snaps into place, securing the drive.



---

**CAUTION** Ensure that the optical drive is secure. Failure to do so can cause damage to the drive when moving the workstation.

---

2. Connect the power, data, and audio (if required) cables to the drive and workstation.



---

**NOTE** The audio cable is only required for Linux-based systems.

---

3. If you are installing more than one optical drive, route the cable as in the following image.



**NOTE** The optical drive cable is routed under the system board.

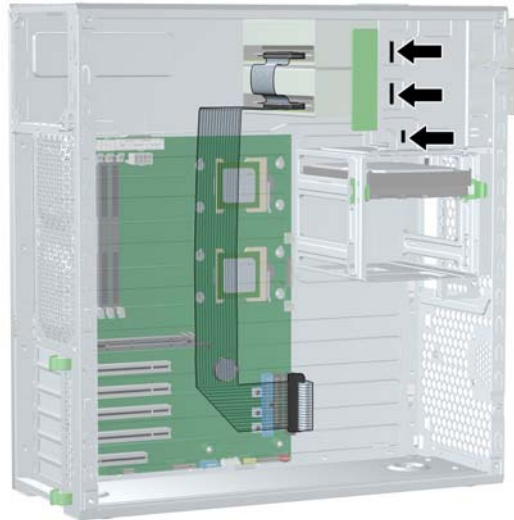

**Figure 4-35** Connecting the optical drive cable to the system board

## Replacing optical drive data cable

1. Disconnect power from the system ([Predisassembly procedures on page 57](#)), remove the side access panel ([Side access panel on page 63](#)), remove all expansion boards and graphics cards, remove the CPU heatsinks, disconnect the optical IDE cable from the system board, and remove the system board.
2. Remove the plastic ties and tape from the IDE cable, then remove the IDE cable.
3. Replace the cable and cable ties. Refer to the previous image for cable routing information.

## Diskette drive (optional)

To remove a diskette drive:

1. Disconnect power from the system ([Predisassembly procedures on page 57](#)), remove the side access panel ([Side access panel on page 63](#)), and the front bezel ([Front Bezel on page 64](#)).



2. Disconnect the cables from the back of the diskette drive.

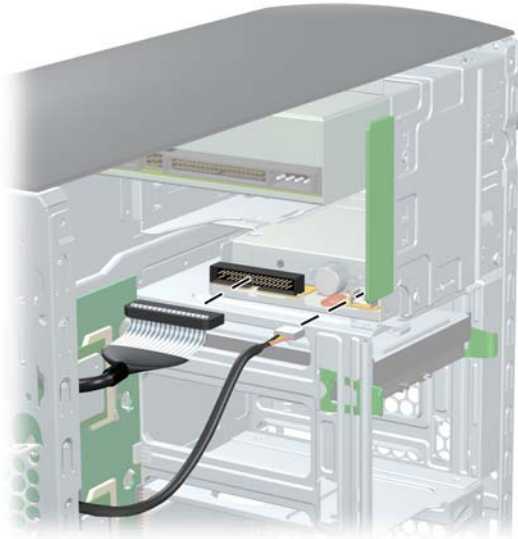

**Figure 4-36** Disconnecting the cables from the diskette drive

3. While lifting the green drive-lock release lever **1**, slide the drive forward **2** out of the chassis.

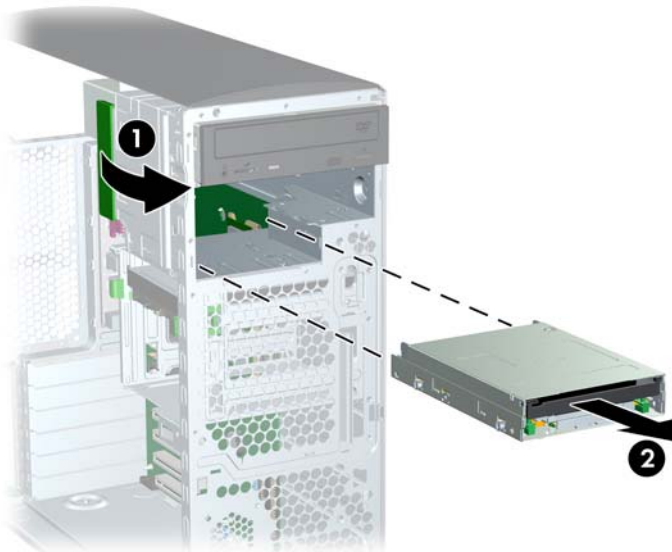

**Figure 4-37** Removing the diskette drive from the chassis

To replace an optional diskette drive:

1. Lift the green drive-lock release lever while sliding the diskette drive into the bay. When the diskette drive is partially inserted, release the drive-lock release lever and slide the drive inward until the drive snaps into place, securing the drive.

2. Route the diskette drive data cable between the system board and the hard drive cage. Your cable might look different than the one shown.

 **CAUTION** The cable must stay between the system board and the hard drive cage. It might be necessary to push the cable down so that it catches on the system board. This routing method is important because you do not want to interfere with the CPU heatsink fans or block airflow.



**Figure 4-38** Routing the diskette drive cable to the system board

3. Connect the cables to the back of the diskette drive.

## Hard drive

### Replacing a hard drive

For more information on SATA hard drives and the SATA RAID configuration, see Appendix B, “SATA Devices.”

### Removing a hard drive

1. Disconnect power from the system ([Predisassembly procedures on page 57](#)) and remove the side access panel ([Side access panel on page 63](#)).
2. Disconnect the cables **1** from the hard drive.

3. Push in on the green drive-lock release tabs **2** and slide the hard drive out **3** of the chassis.

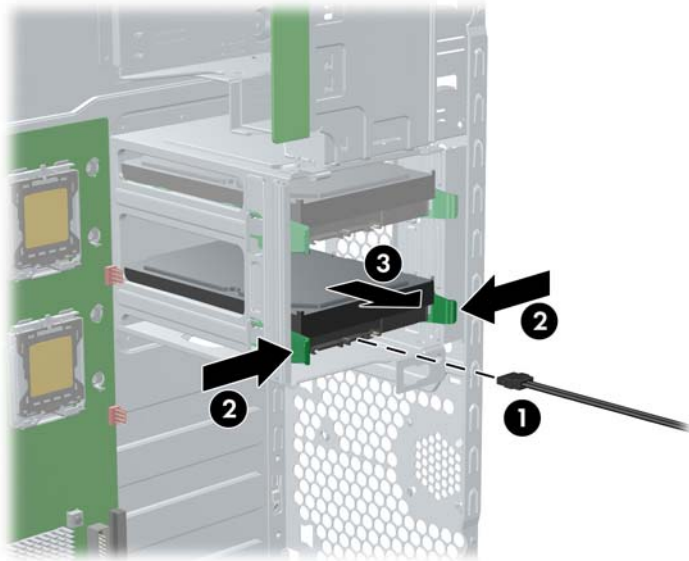

**Figure 4-39** Removing the hard drive

### Installing a hard drive

1. Select a drive bay in which to install the drive.
2. In the hard drive cage, squeeze the green tabs and slide two rails out of the empty bay.
3. Attach the rails to the hard drive. Align the pins on the rails with the hard drive holes and snap the rails into place.



**CAUTION** Do not damage the PC board on the bottom of the hard drive with the pins on the rails.

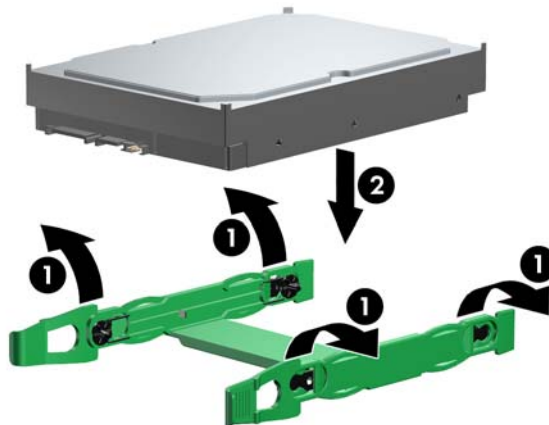

**Figure 4-40** Attaching the rails to the hard drive

4. Push the drive **1** into the selected bay until it snaps into place.

5. For a SATA hard drive, attach a data cable **2** from a SATA connector on the system board to the hard drive, and attach a power cable (not illustrated) to the drive.

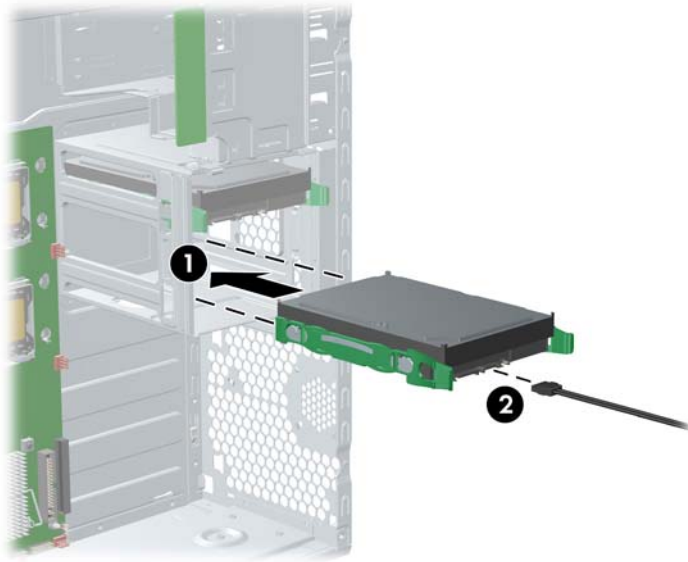

**Figure 4-41** Replacing the SATA hard drive

6. For a SAS hard drive, attach a SAS-to-SATA cable adapter to the connector on the hard drive.

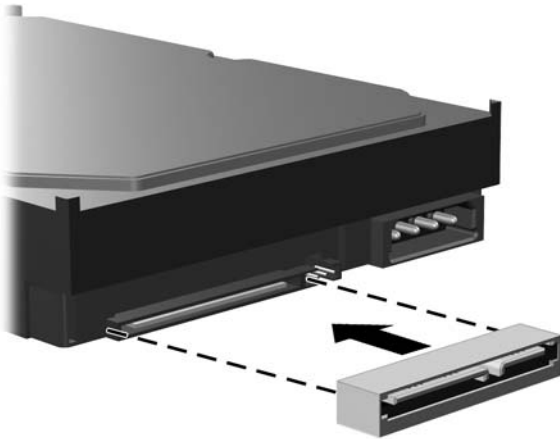

**Figure 4-42** Attaching the SAS-to-SATA cable adapter

7. Insert the SAS controller card into an available PCI expansion slot.

8. Connect one end of the SAS data cable to the controller card and the other end to the SAS hard drive, as shown in the following illustration. Also attach a power cable (not illustrated).



**Figure 4-43** Connecting data cable to SAS controller card

## CPU heatsink

### Removing the CPU heatsink



**NOTE** The following illustrated CPU heatsink is typical of what you might have in your workstation. Be aware that different variations of the CPU heatsinks exist, but the overall procedures listed are sufficient to assist you in removing the CPU heatsink.

1. Shut down the system, disconnect power from the system, and remove the side access panel.
2. Loosen the four processor screws slowly and evenly. Loosen one pair of diagonally opposite screws **1** until the screw shanks disengage from the system board, and then loosen the remaining pair **2**. Do not fully loosen one screw, and then move on to the next. Loosen all of the screws a little at a time, being sure the processor remains level.

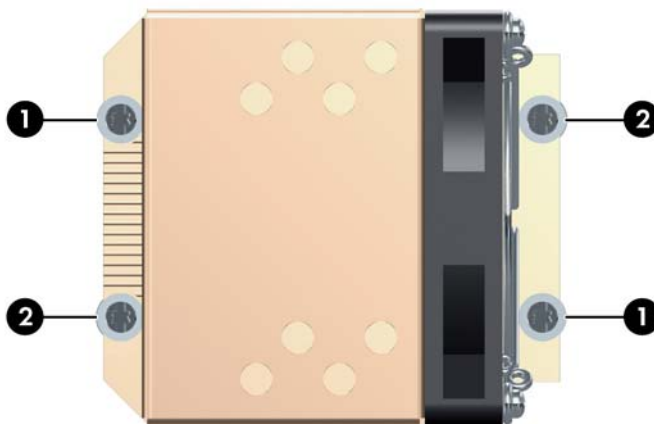

**Figure 4-44** Identifying proper screw loosening sequence

3. Disconnect the CPU heatsink fan connector **3** from the system board.
4. Before lifting the heatsink, carefully break the adhesive compound between the CPU heatsink and processor by rotating the heatsink back and forth. Then, lift the CPU heatsink.

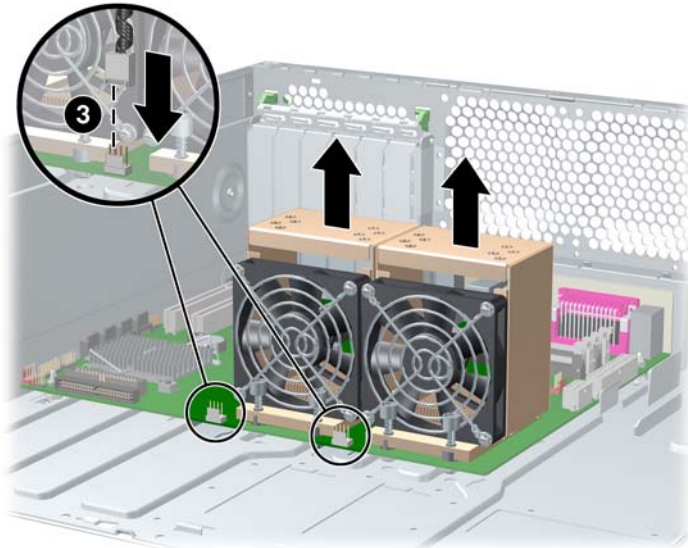

**Figure 4-45** Removing the CPU heatsink from the system board

5. Use alcohol and a soft cloth to clean all of the thermal interface material residue from the CPU heatsink and processor.



**CAUTION** Allow the alcohol on the processor and CPU heatsink to dry completely.

## Replacing the CPU heatsink

1. Disconnect power from the system ([Predisassembly procedures on page 57](#)). Remove the side access panel ([Side access panel on page 63](#)) and the CPU heatsink ([Removing the CPU heatsink on page 91](#)).
2. Use alcohol and a soft cloth to clean all of the thermal interface material residue from the CPU heatsink and processor.



**CAUTION** Allow the alcohol on the processor and CPU heatsink to dry completely.

3. Apply the thermal grease to center of the processor.

- Place the CPU heatsink on top of the processor and align the four mounting screws with the holes **1** in the system board.



**NOTE** If both CPU heatsinks were removed, be sure all system board standoffs engage with the keyholes in the chassis, be sure the system board connectors engage correctly with the rear I/O panel, and push back on the system board while engaging the CPU heatsink screws with the chassis standoffs. You only must push back when trying to engage the first screw.

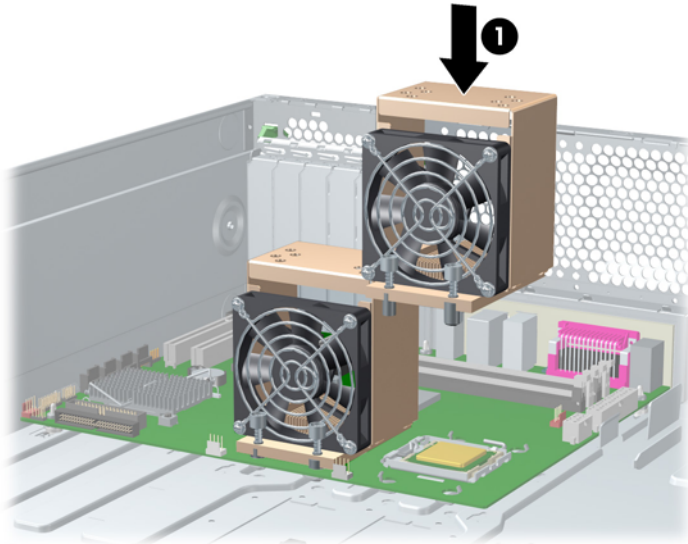

**Figure 4-46** Replacing the CPU heatsink on the system board

- Tighten the four CPU heatsink screws. First, tighten all of the screws partially so that the CPU heatsink remains level. Next, fully tighten one pair of diagonally opposite screws **1** and fully tighten the remaining pair **2**. Tighten firmly to a torque setting of 6 in-lb.

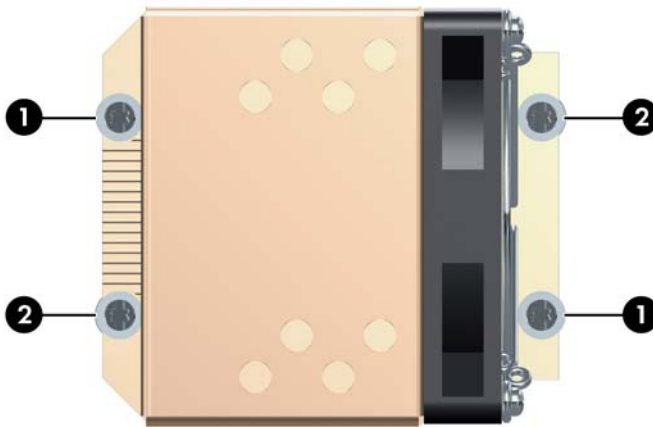

**Figure 4-47** Identifying proper screw tightening sequence



6. Connect the CPU heatsink fan connector to the system board **1**.

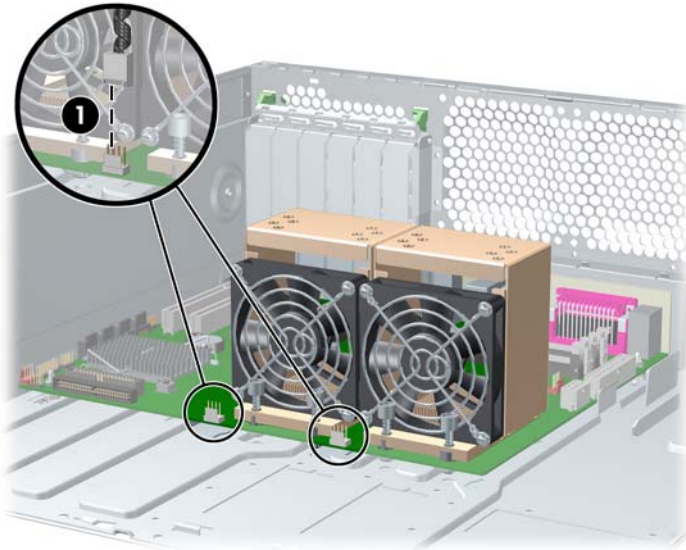
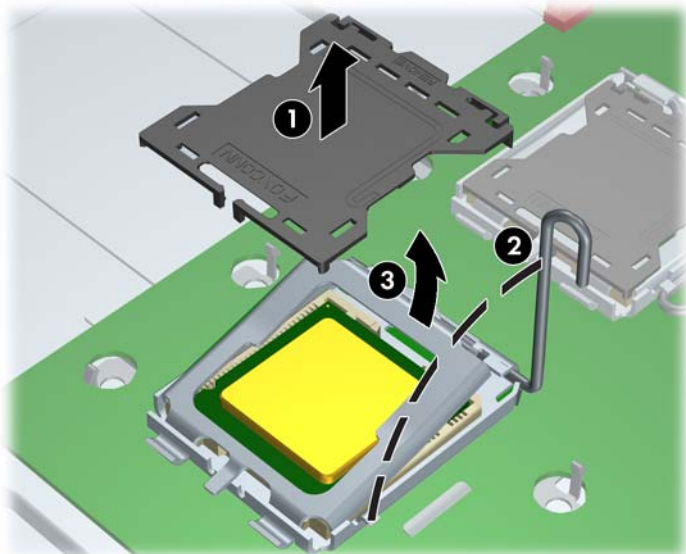

**Figure 4-48** Identifying proper screw removal order

## Processor

### Removing the processor

1. Disconnect power from the system ([Predisassembly procedures on page 57](#)). Remove the side access panel ([Side access panel on page 63](#)) and the CPU heatsink ([Removing the CPU heatsink on page 91](#)).
2. Lift the processor cover **1** off the assembly. Raise the processor socket handle fully **2** (the full swing angle of the lever is approximately 135 degrees). Lift the processor retainer **3** away from the processor.



**Figure 4-49** Raising the processor socket handle



3. Pull the processor straight out of the socket.

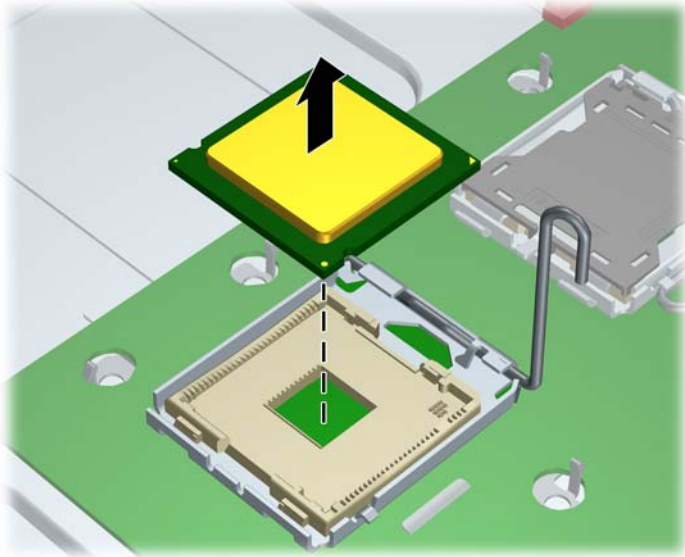

**Figure 4-50** Lifting the processor out of the socket



---

**CAUTION** To avoid bending the socket pins, keep the processor perfectly flat when removing or installing it.

---



---

**NOTE** Store the processor in a safe place where it will not be damaged.

---

## Replacing the processor

1. Disconnect power from the system ([Predisassembly procedures on page 57](#)), remove the side access panel ([Side access panel on page 63](#)), the CPU heatsink ([Removing the CPU heatsink on page 91](#)), and the processor ([Removing the processor on page 94](#)).
2. Raise the processor socket handle fully (the full swing angle of the lever is approximately 135 degrees).



---

**CAUTION** Socket pins are delicate and bend easily. Use extreme care when placing the processor in the socket to avoid bending pins.

---

3. Align the triangle on the top of the processor with the triangle on the corner of the processor socket and install the processor into the socket. Ensure that the underside of the processor is level with the top of the processor socket. Lightly press down on the top of the processor while closing the socket lever.

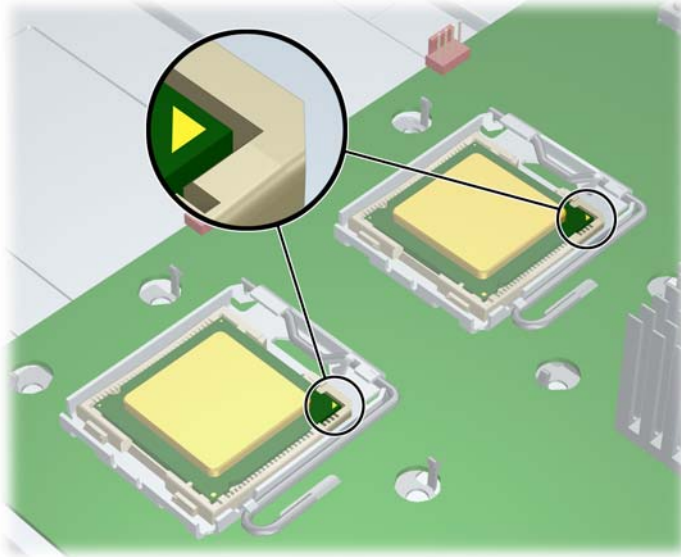

**Figure 4-51** Seating the processor

4. Be sure the processor is properly seating in the socket by carefully trying to lift the processor out of the socket with your fingers. A properly seated processor does not lift out of the socket.

## System board

### Removing the system board

1. Disconnect power from the system ([Predisassembly procedures on page 57](#)) and remove the side access panel ([Side access panel on page 63](#)), remove all expansion boards, graphics cards, and the CPU heatsink ([CPU heatsink on page 91](#)).
2. Disconnect all cabling from the system board.



**CAUTION** Be sure you can differentiate which power cable was disconnected from the PCI Express x16 graphics card and which power cable was disconnected from the system board. These two cables have different pin counts and different colors. The PCI Express power cable has a 6-pin black connector, and the system board power cable has an 8-pin white connector. When power is present, you must **never** connect the PCI Express power cable to the system board. If you do so, the system board can be damaged and your warranty voided.



**NOTE** Make note of the cable connections before disconnecting them from the system board. Refer to [Power connections to drives on page 83](#) for more information.

**NOTE** Ensure CPU heatsink has been removed.

3. Slide the system board forward 1 to disengage the metal mounting standoffs from the chassis.



---

**CAUTION** Do **not** attempt to remove the 6 system board mounting screws. These are permanently secured and are not removable.

---

4. Lift the system board out **2** of the chassis, being careful not to damage the cables and rear panel connectors.

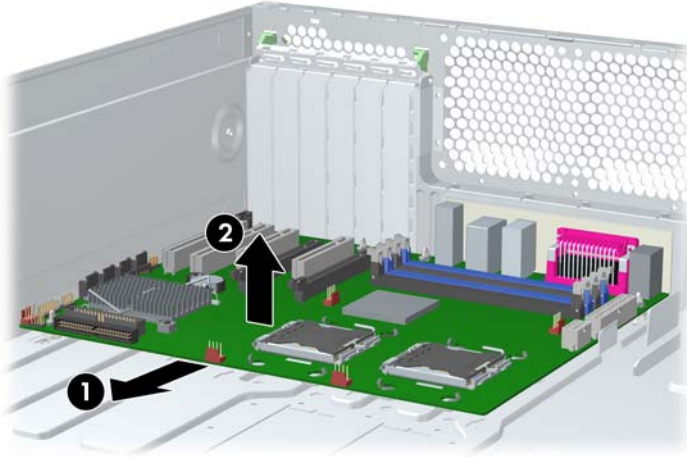

**Figure 4-52** Removing the system board

## Replacing the system board

1. Insert the system board straight down and be sure all system board standoffs engage with the keyholes in the chassis.



---

**NOTE** Be sure the system board connectors engage correctly with the rear I/O panel.

---

2. Push back while maintaining downward pressure on the board, so all standoffs remain engaged.
3. Install the heatsink ([Replacing the CPU heatsink on page 92](#)).



# 5 System diagnostics and troubleshooting

This chapter discusses the tools available for diagnosing and troubleshooting system issues.

- [E-Support on page 100](#)
- [Troubleshooting checklist on page 101](#)
- [LED color definitions on page 102](#)
- [HP Insight Diagnostics Offline Edition on page 103](#)
- [Diagnostic error codes on page 108](#)
- [Troubleshooting scenarios and solutions on page 111](#)
- [POST and error messages on page 128](#)

# E-Support

## Help & Support Center and E-Support

Help & Support Center (HSC) provides online access to technical support information, software updates and downloads, diagnostic tools, and HP support contact information.

To open HSC from your desktop, click **Start>Help and Support**.

HSC contains four sections:

- HP Product Information (requires Internet access)—Links to the HP Technical Support website for your product. You can access all related documentation, downloads and updates, tools, and more.
- HP Software & Driver Downloads (requires Internet access)—Links to HP specific software downloads and updates.
- HP Support Tools (requires Internet access)—Links to self-help tools and diagnostics offered by HP Instant Support Professional Edition.
- Contact HP for Support (does not require Internet access)—Provides two different options:
  - Chat with an expert online (requires Internet access)—Provides a tool to communicate with a support specialist online through **Active Chat**.
  - Call a support agent—Provides hardware details about the workstation and HP support contact phone number worldwide.

# Troubleshooting checklist

Before running any of the diagnostic utilities, use the following checklist to find possible solutions for workstation or software problems.

- Are the workstation and monitor connected to a working electrical outlet?
- Is the workstation powered on?
- Is the green power light illuminated?
- Is the monitor on?
- Is the green monitor light illuminated?
- Adjust the monitor brightness and contrast controls if the monitor is dim.
- Press and hold any key. If the system beeps, then the keyboard is operating correctly.
- Check all cables for loose or incorrect connections.
- Reconfigure the workstation after installing a non-PnP expansion board or other option, such as a diskette drive.
- Are all of the necessary device drivers installed?
- Have all printer drivers been installed for each application?
- Remove all diskettes and CDs from the drives before you power on the system.
- Are you running the latest BIOS version, drivers, and software updates?

## LED color definitions

An LED light exists on the front panel of your workstation. The following table describes what each color signifies.

**Table 5-1** LED color definitions

LED state	LED color	System status
Solid	Green	System is on.
Flashing	Green	System is in Standby.
Solid or flashing	Red	System has experienced an error. Refer to <a href="#">Diagnostic LED codes on page 108</a>
None	No light	System is in Hibernate, or it is off.



# HP Insight Diagnostics Offline Edition

The diagnostics utility enables you to perform testing and to view critical computer hardware and software configuration information from various sources. This utility enables you to:

- Run diagnostics
- View the hardware configuration of the system

## Key features and benefits

HP Insight Diagnostics simplifies the process of effectively identifying, diagnosing, and isolating the hardware issues.

In addition to robust management tools, service tools can be invaluable in quickly resolving system problems. To streamline the service process and resolve problems quickly, it is necessary to have the right information available at the time that a service call is placed. The primary information requirement, which is also the one that provides the greatest insight into potential system issues, is the configuration of the system. Insight Diagnostics helps provide higher system availability. Typical uses of the Insight Diagnostics are:

- Testing and diagnosing apparent hardware failures
- Documenting system configurations for upgrade planning, standardization, inventory tracking, disaster recovery, and maintenance
- Sending configuration information to another location for more in-depth analysis

## Theory of operation

Insight Diagnostics Offline Edition operates in offline mode only. The operating system is not running and software information from the system is not available to the diagnostics.

Offline Survey is available to display the current system configuration.

The Insight Diagnostics Test feature provides the capability to test functionality of all the major hardware components in the system. The Test feature is designed to be flexible to enable you to customize test selections by providing different modes and types of testing.

A Quick Test provides a predetermined script where a sample of each hardware component is exercised and requires no user intervention.

A Complete Test provides a predetermined script during which each hardware component is fully tested. You can select Interactive or Unattended tests. This will change the devices tested during the Complete Test. There are more tests available in the interactive mode, but these require user intervention.

A Custom Test provides the most flexibility in controlling the testing of a system. The Custom Test mode enables you to specifically select which devices, tests, and test parameters are run. You can select tests that do not require any user interaction through the Interactive and Unattended tests modes.

## Diagnostic Utility on CD

HP Insight Diagnostics is available on the *Documentation Library* CD that was shipped with your workstation.

To start the diagnostic utility on the *Documentation Library* CD:

1. Power on your workstation and press the **F10** key during the initial boot process to enter the Computer Setup (F10) Utility.
2. Select your language from the list and press the **Enter** key. In the Computer Setup Utilities menu, four headings are displayed: **File**, **Storage**, **Security**, and **Advanced**. There may be other headings depending on the workstation.
3. Use the right arrow key to select **Storage**.
4. Use the down arrow key to select **Boot Order**, and press **Enter**.
5. Select **CD-ROM Drive** and enable it as a bootable device by pressing the **F5** key (if not already enabled, pressing the **F5** key again disables the device). Default setting is enabled.
6. Set the CD-ROM Drive to the top of the boot order. To do this, select **CD-ROM**, press the **Enter** key, and use the up arrow to move it to the top of the boot order.
7. To apply and save changes, press the **F10** key, and select **File>Save Changes** and **Exit**.
8. Insert the *Documentation Library* CD into the workstation.
9. Restart your system and HP Insight Diagnostics launches automatically.

## Downloading the latest diagnostic utility

1. Access <http://www.hp.com>.
2. Click the **Support & Drivers** link.
3. Select the **Download driver and software** radio button.
4. Enter your product number (for example, xw6400) in the text box and press the **Enter** key.
5. Select your operating system.
6. Click the **Diagnostic** link.
7. Locate **HP Insight Diagnostics Offline** and click **Download**.

## User Interface

### Navigation

The Insight Diagnostics home page contains the following tabs: **Survey**, **Test**, **Status**, **Log**, and **Help**. These tabs separate the major functions of Insight Diagnostics.

### Survey tab

When the Survey tab is selected, the **Survey** menu displays and enables you to view important system configuration information. The **Summary** view limits the amount of data displayed, while the **Advanced** view shows all the data in the selected category. Regardless of whether you choose **Advanced** or **Summary**, the following categories of information are available on the **Survey** menu:

**Overview**—Gives you a listing of general information about the computer.

**All**—Gives a listing of all information about the computer.

**Architecture**—Shows the type of bus the computer uses as well as BIOS information. In addition, if the bus is PCI, information about the PCI configuration is displayed.

**Asset Control**—Shows the serial number of the computer and also provides processor information.

**Communication**—Shows information about the computer parallel (LPT) and serial (COM) port settings, USB, and network controller information.

**Graphics**—Shows information about the graphics subsystem of the computer.

**Input Devices**—Shows information about the type of keyboard and mouse.

**Memory**—Shows information about all memory in the computer, including memory on the board and any memory modules installed.

**Miscellaneous**—Shows information obtained from the computers configuration memory (CMOS), BIOS data area, Interrupt Vector table, and diagnostics component information.

**Storage**—Shows information about storage media connected to the computer, including all fixed disks, floppy drives, and CD-ROM drives.

**System**—Shows product type, processor type and speed, coprocessor information, and information about all ROMs in the computer.

## Test tab

The Insight Diagnostics utility provides the capability to test all the major pieces of hardware in the system. You can select from several types of tests:

**Quick Test**—Provides a predetermined script during which a sample of most hardware components is exercised and requires no user intervention.

**Complete Test**—Provides a predetermined script during which most hardware components are fully tested. You can select **Interactive** or **Unattended** tests. This will change the devices tested during the Complete Test. More tests are available in the interactive mode, but these require user intervention.

**Custom Test**—Provides the most flexibility in controlling the testing of a system. The Custom Test mode enables you to specifically select which devices, tests, and test parameters are run. You can select tests that do not require any user interaction through the **Interactive** and **Unattended** test modes. More tests are available in the interactive mode, but these tests require user intervention.

To begin testing:

1. Click the **Test** tab.
2. Select **Type of Test** to perform and then select **Test Mode**, either **Interactive** or **Unattended**.
3. Choose how you want the test to be executed, either **Number of Loops** or **Total Test Time**.
  - When choosing to run the test over a specified number of loops, enter the number of loops to perform.
  - If you want to run the diagnostic test for a specified time period, enter the amount of time in minutes.
4. Click **Begin Testing** in the lower right corner of the display to start the test.

While tests are being performed, you can monitor the progress by viewing the Status tab. Any errors that are detected are summarized in the Error Log. Select **Save** to save the report to floppy or a USB Key Drive if attached.

If the diagnostics utility detects an error during a test, the user can mouse-over the failed text in the Status tab to display additional information for the type of error and the error code.

To view all test failure information, **Error Log**. To view the status of all testing that has been performed, click the **Log** tab.

## Status tab

The Status tab displays the status of the selected tests. The type of test executed (for example, **Quick, Complete, Custom**) is displayed. The main progress bar displays the percent complete of the current set of tests. While testing is in progress, **Cancel Testing** is displayed. This selection will cancel the test job.

After testing has completed, the **Cancel** testing button is replaced with two buttons, **Select New Tests** and **Retest**. The **Select New Tests** button enables you to go back to the previous test selection page to select a new set of tests. The **Retest** button retests the last set of tests executed. This enables you to rerun the set of tests without having to go back to the test selection page.

The Status page also shows:

- The devices being tested
- The tests that are running
- The overall Test time
- The individual Test times
- The condition status of each test

## Log tab

The Log tab consists of three views.

**Test Log**—Displays all tests that have been executed, number of times the test has been executed, number of times the test failed, and the time it took to complete the test. The Clear Test Log button will clear the contents of the Test Log.

**Error Log**—Displays the tests that have failed during the diagnostic testing. Besides displaying the device and test, this section might also include error details. The description section describes the error that the diagnostic test found. The Recommended Repair will give a recommended action that should be performed to resolve the failed hardware. The error count is the number of times the test has failed. The Clear Error Log button will clear the contents of the Error Log.

## Help tab

The Help tab has three views:

- **HP Insight Diagnostics**—Provides introductory and detailed information about Insight Field Diagnostics.
- **Error Codes**—Provides error code listings. It includes device tested, message, and recommended repair information.
- **Test Components**—Reloads and refreshes all components and display component details after the refresh.

# Diagnostic error codes

This sections provides an overview of the diagnostic LEDs and error codes that are related to your workstation.

## Diagnostic LED codes



**NOTE** The beeps are heard through the on-board piezo speaker and not the chassis speaker. The flashing lights and beeps repeat for five cycles. After that, only the flashing lights repeat.

**Table 5-2** Diagnostic LED codes

Chassis indicator LEDs	
Power LED and sound activity	Diagnosis and service action
None	<p>System does not power on. Press the power button. If HDD LED = GREEN, then:</p> <ol style="list-style-type: none"><li>1. Remove expansion cards one at a time.</li><li>2. Replace the system board.</li></ol> <p>OR</p> <p>Press the power button. If HDD LED does not illuminate, then:</p> <ol style="list-style-type: none"><li>1. Verify that the unit is plugged into a working AC outlet.</li><li>2. Open access panel and verify that the power button harness is properly connected to the inline front panel I/O device assembly connector.</li><li>3. Verify that the power supply cables are properly connected to the system board.</li><li>4. Verify the power supply functionality.<ol style="list-style-type: none"><li>a. Disconnect AC power.</li><li>b. Remove all internal power supply cables from the system board.</li><li>c. Plug in AC power.</li></ol></li><li>• If the power supply fan spins and the BIST LED illuminates, then the power supply is good. Replace the system board.</li><li>• If the power supply fan does not spin or the BIST LED does not illuminate, replace the power supply.</li></ol>
Blinks red 2 times, once per second, then 2-second pause, 2 beeps	<p>Thermal shutdown has occurred:</p> <ol style="list-style-type: none"><li>1. Ensure that the workstation air vents are not blocked and the cooling fan is running.</li><li>2. Open the access panel, press power button, and determine whether the processor fan spins. If it does not spin, ensure the fan cable is plugged into the system board. Ensure that the fan is properly seated.</li><li>3. If the fan is plugged in and seated but not spinning, then replace processor fan.</li><li>4. Reseat the CPU heatsink and verify that the fan assembly properly attached.</li></ol>

**Table 5-2** Diagnostic LED codes (continued)

Chassis indicator LEDs	
Power LED and sound activity	Diagnosis and service action
Blinks red 3 times, once per second, then 2-second pause, 3 beeps	CPU not installed. <ol style="list-style-type: none"><li>1. Install CPU.</li><li>2. Reseat CPU.</li></ol>
Blinks red 4 times, once per second, then 2-second pause, 4 beeps	Power supply failure. <ol style="list-style-type: none"><li>1. Open the access panel, and be sure the four-wire power supply cable is properly connected to the system board.</li><li>2. Locate faulty device by removing all devices and then reinstalling one at a time until workstation fails. Replace the device causing the failure. Continue adding devices to ensure all are functioning properly.</li><li>3. Verify the power supply functionality.<ol style="list-style-type: none"><li>a. Disconnect AC power.</li><li>b. Remove all internal power supply cables from the system board.</li><li>c. Plug in AC power.<ul style="list-style-type: none"><li>• If the power supply fan spins and the BIST LED illuminates, then the power supply is good. Replace the system board.</li><li>• If the power supply fan does not spin or the BIST LED does not illuminate, replace the power supply.</li></ul></li></ol></li></ol>
Blinks red 5 times, once per second, then 2-second pause, 5 beeps	Pre-video memory error. <ol style="list-style-type: none"><li>1. Reseat memory modules.</li><li>2. Replace memory modules one at a time to find the faulty module.</li><li>3. Replace third-party modules with HP memory.</li><li>4. Replace system board.</li></ol>
Blinks red 6 times, once per second, then 2-second pause, 6 beeps	Pre-video graphic card error. For systems with integrated graphics, replace system board.  For systems with graphic cards: <ol style="list-style-type: none"><li>1. Reseat the graphic card. Power on the system.</li><li>2. Replace the graphic card.</li><li>3. Replace the system board.</li></ol>
Blinks red 7 times, once per second, then 2-second pause, 7 beeps.	System board failure (ROM detected failure before video). Replace system board.

**Table 5-2** Diagnostic LED codes (continued)

<b>Chassis indicator LEDs</b>	
<b>Power LED and sound activity</b>	<b>Diagnosis and service action</b>
Blinks red 8 times, once per second, then 2-second pause, 8 beeps	Invalid ROM based on bad checksum. <ol style="list-style-type: none"><li>1. Reflash ROM.</li><li>2. Replace system board.</li></ol>
Blinks red 9 times, once per second, then 2-second pause, 9 beeps	System powers on but is unable to boot. <ol style="list-style-type: none"><li>1. Replace the system board.</li><li>2. Replace the processor.</li></ol>



# Troubleshooting scenarios and solutions

This section presents an extensive overview of various troubleshooting scenarios and includes possible solutions for each.

## Solving minor problems

Table 5-3 Minor problems

Problem	Cause	Possible Solution
Workstation appears locked up and will not shut down when the power button is pressed.	Software control of the power switch is not functional.	<ol style="list-style-type: none"> <li>1. Press and hold the power button for at least four seconds until the workstation shuts down.</li> <li>2. Disconnect electrical plug from outlet.</li> </ol>
Workstation seems to be locked up.	Program in use has stopped responding to commands.	<ol style="list-style-type: none"> <li>1. Attempt the normal Windows shutdown procedure.</li> <li>2. Restart the workstation using the power button.</li> </ol>
Workstation date and time display is incorrect.	Real-time clock (RTC) battery might need to be replaced.	<ol style="list-style-type: none"> <li>1. Reset the date and time under Control Panel.</li> <li>2. Replace the RTC battery.</li> </ol>
Workstation appears to pause periodically.	Network driver is loaded and no network connection is established.	Establish a network connection, or use Computer Setup or Microsoft Windows Device Manager to disable the network controller.
Cursor will not move using the arrow keys on the keypad.	The <b>Num Lock</b> key might be on.	Press the <b>Num Lock</b> key. The <b>Num Lock</b> key can be disabled (or enabled) in Computer Setup.
Poor performance is experienced.	Processor is hot.	<ol style="list-style-type: none"> <li>1. Be sure airflow to the workstation is not blocked.</li> <li>2. Be sure the fans are connected and working properly (some fans only operate when needed).</li> <li>3. Be sure the CPU heatsink is installed properly.</li> </ol>
	Hard drive is full.	Transfer data from the hard drive to create more space on the hard drive.
Workstation powered off automatically and the Power LED flashes red 2 times, once every second, followed by a 2-second pause, and two simultaneous beeps are heard.	Processor thermal protection activated.	<ol style="list-style-type: none"> <li>1. Be sure workstation air vents are not blocked and the cooling fan is running.</li> </ol>
	<p>A fan might be blocked or not turning.</p> <p>OR</p> <p>The CPU heatsink is not properly attached to the processor.</p>	<ol style="list-style-type: none"> <li>2. Open the access panel, press the power button, and see if the processor fan spins. If not spinning, be sure the fan's cable is plugged into the system board header. Be sure the fan is fully/properly seated or installed.</li> <li>3. Replace the processor fan.</li> <li>4. Reseat CPU heatsink and verify that the fan assembly is properly attached.</li> </ol>
System does not power on, and the LEDs on the front of the workstation are not flashing.	System unable to power on.	Press and hold the power button for less than 4 seconds. If the hard drive LED turns green, then:
		<ol style="list-style-type: none"> <li>1. Remove the expansion cards.</li> <li>2. Replace the system board.</li> </ol>
		OR

**Table 5-3** Minor problems (continued)

Problem	Cause	Possible Solution
		Press and hold the power button for less than 4 seconds. If HDD LED does not illuminate, then:
		<ol style="list-style-type: none"><li>1. Verify that the unit is plugged into a working AC outlet.</li><li>2. Open the access panel and verify that the power button harness is properly connected to the inline front panel I/O device assembly connector.</li><li>3. Verify that the power supply cables are properly connected to the system board.</li><li>4. Verify the power supply functionality.<ol style="list-style-type: none"><li>a. Disconnect AC power.</li><li>b. Remove all internal power supply cables from the system board.</li><li>c. Plug in AC power.<ul style="list-style-type: none"><li>• If the power supply fan spins and the BIST LED illuminates, then the power supply is good. Replace the system board.</li><li>• If the power supply fan does not spin or the BIST LED does not illuminate, replace the power supply.</li></ul></li></ol></li></ol>

## Solving power supply problems

### Testing power supply

Before replacing the power supply, use the Built-In Self-Test (BIST) feature to learn if the power supply still works.

To test the power supply:

1. Unplug the AC power.
2. Disconnect all internal power supply cables from the system board.
3. Plug in AC power.
  - If the green BIST LED (illustrated below) on the rear of the workstation is illuminated **and** the fan is spinning, the power supply is functional.
  - If the green BIST LED (illustrated below) is not illuminated **or** the fan is not spinning, replace the power supply.

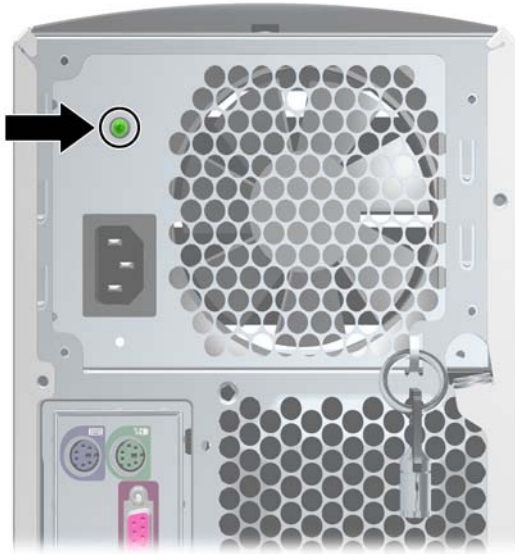

**Figure 5-1** Testing power supply with BIST LED

**Table 5-4** Power supply problems

<b>Problem</b>	<b>Cause</b>	<b>Solution</b>
Power supply shuts down intermittently.	Power supply fault.	Replace the power supply.

**Table 5-4** Power supply problems (continued)

Problem	Cause	Solution
Workstation powered off automatically and the Power LED flashes red 2 times, once every second, followed by a 2-second pause.	Processor thermal protection activated.	1. Be sure that the workstation air vents are not blocked and the cooling fan is running.
	A fan might be blocked or not turning.  OR  The CPU heatsink fan assembly is not properly attached to the processor.	2. Open the access panel, press the power button, and determine whether the processor fan spins. If the processor fan is not spinning, be sure the fan's cable is plugged into the system board header. Be sure the fan is properly seated or installed.  3. Replace the processor fan.  4. Reseat CPU heatsink and verify that the fan assembly is properly attached.
Power LED flashes red, once every 2 seconds.	Power failure (power supply is overloaded).	1. Determine whether a device is causing the problem by removing all attached devices). Power on the system. If the system enters the POST, then power off and replace one device at a time and repeat this procedure until failure occurs. Replace the device causing the failure. Continue adding devices one at a time to ensure all devices are functioning properly.  2. Verify the power supply functionality. <ul style="list-style-type: none"> <li>a. Disconnect AC power.</li> <li>b. Remove all internal power supply cables from the system board.</li> <li>c. Plug in AC power. <ul style="list-style-type: none"> <li>• If the power supply fan spins and the BIST LED illuminates, then the power supply is good. Replace the system board.</li> <li>• If the power supply fan does not spin or the BIST LED does not illuminate, replace the power supply.</li> </ul> </li> </ul>

## Solving diskette problems

**Table 5-5** Diskette problems

Problem	Cause	Solution
Diskette drive light stays on.	Diskette is damaged.	In Microsoft Windows 2000 and Microsoft Windows XP, right-click <b>Start</b> , click <b>Explore</b> , and select a drive. Select <b>File&gt;Properties&gt;Tools</b> . Under <b>Error-checking</b> , click <b>Check Now</b> .
	Diskette is incorrectly inserted.	Remove and reinsert diskette.
	Files on diskette are damaged.	Verify the program diskettes.
Drive not found.	Drive cable is not properly connected.	Reconnect power cable. Be sure that all four pins are connected.
	Cable is loose.	Reseat diskette drive data and power cables.
	Removable drive is not seated properly.	Reseat the drive.

**Table 5-5** Diskette problems (continued)

<b>Problem</b>	<b>Cause</b>	<b>Solution</b>
Diskette drive cannot write to a diskette.	Diskette is not formatted.	Format the diskette.
	Diskette is write-protected.	Use another diskette or remove the write protection.
	Writing to the wrong drive.	Verify the drive letter in the path statement.
	Not enough space is left on the diskette.	Use another diskette.
	Diskette write control is enabled.	Use Computer Setup to verify the storage security feature disabled settings.
Cannot format diskette.	Diskette is damaged.	Replace the damaged disk.
	Invalid media reported.	When formatting a disk in MS-DOS, you might need to specify diskette capacity. For example, to format a 1.44-MB diskette, enter the following command at the MS-DOS prompt:  <b>FORMAT A: /F:1440</b>
A problem has occurred with a disk transaction.	The directory structure is bad, or there is a problem with a file.	In Windows 2000 and Windows XP, right-click <b>Start</b> , click <b>Explore</b> , and select a drive. Select <b>File&gt;Properties&gt;Tools</b> . Under Error-checking, click <b>Check Now</b> .
Diskette drive cannot read a diskette.	Diskette is not formatted.	Format the diskette.
	You are using the wrong diskette type for the drive type.	Verify the type of drive that you are using and use the correct diskette type.
	You are reading the wrong drive.	Verify the drive letter in the path statement.
"Invalid system disk" message is displayed.	Diskette is damaged.	Replace the diskette with a new one.
	A diskette that does not contain the system files needed to start the workstation has been inserted in the drive.	When drive activity stops, remove the diskette and press the <b>Spacebar</b> . The workstation should start up.
	Diskette error has occurred.	Restart the workstation by pressing the power button.
Cannot Boot to Diskette.	Diskette is not bootable.	Replace with a bootable diskette.
	Diskette boot has been disabled in Computer Setup.	Run Computer Setup and enable diskette boot in <b>Storage&gt;Boot Order</b> .
	Removable media boot has been disabled in Computer Setup.	Run Computer Setup and enable Removable Media Boot in <b>Storage&gt;Storage Options</b> .
	Diskette MBR validation is enabled.	Run Computer Setup and disable Diskette MBR Validation in <b>Storage&gt;Storage Options</b> .

## Solving

**Table 5-6** Hard drive problems

Problem	Cause	Solution
Hard drive error occurs.	Hard disk has bad sectors or has failed.	Use a utility to locate and block usage of bad sectors. If necessary, reformat the hard disk.  Or, run DPS Self-test if the drive is detected by the BIOS.
Disk transaction problem.	The directory structure is bad, or there is a problem with a file.	Right-click <b>Start</b> , click <b>Explore</b> , and select a drive. Select <b>File&gt;Properties&gt;Tools</b> . Under Error-checking, click <b>Check Now</b> .
Drive not found (identified).	Loose cable.  The system might not have automatically recognized a newly installed device.	Verify cable connections.  <ol style="list-style-type: none"> <li>1. Run Computer Setup.</li> <li>2. If the system still does not recognize the new device, verify to see if the device is listed within Computer Setup. If it is listed, the probable cause is a driver problem. If it is not listed, the probable cause is a hardware problem.</li> <li>3. If this drive is newly installed, enter <b>Setup</b> and try adding a POST delay under <b>Advanced&gt;Power-On</b>.</li> </ol>
	Drive jumper settings might be incorrect.	If the drive is a secondary drive that has just been installed on the same cable as the primary drive, verify that the jumpers for both drives are set correctly.
	Drive responds slowly immediately after power-up.	Run Computer Setup and increase the POST Delay in <b>Advanced&gt;Power-On Options</b> .
Nonsystem disk/NTLDR missing message.	System is trying to start from a non-bootable diskette.	Remove the diskette from the diskette drive.
Nonsystem disk/NTLDR missing message.	System is trying to start from a damaged hard drive.	<ol style="list-style-type: none"> <li>1. Insert a bootable diskette into the diskette drive and restart the workstation.</li> <li>2. If the hard drive is still inaccessible and MBR Security is enabled, try restoring the previously saved MBR image by entering <b>Setup</b> and selecting <b>Security&gt;Restore Master Boot Record</b>.</li> </ol>
	System files missing or not properly installed.	<ol style="list-style-type: none"> <li>1. Insert a bootable system diskette and restart.</li> <li>2. Verify that the hard drive is partitioned and formatted.</li> <li>3. Install system files for the appropriate operating system if necessary.</li> </ol>
	Hard drive boot disabled in Computer Setup.	Run Computer Setup and enable the hard drive entry in the <b>Storage&gt;Boot Order</b> list.
Second Ultra ATA hard drive does not perform optimally.	Using the wrong cable for the drive type.  Both slow and fast UATA devices are on the same data cable.	Reinstall the second Ultra ATA hard drive using an 80-conductor cable (standard on select models.)  Connect slower UATA devices to a separate data cable connected to the secondary IDE (ATA) controller.
Workstation will not start.	Hard drive is damaged.	Observe the beeps and LEDs on the front of the workstation. Refer to <a href="#">POST and error messages on page 128</a> .

## Solving display problems

**Table 5-7** Display problems

Problem	Cause	Solution		
Blank screen (no video).	The cable connections are not correct.	Verify the cable connections from the monitor to the workstation and to a working electrical outlet.		
	The monitor is off.	Switch the monitor to on (LED is on). You might need to refer to the monitor manual for an explanation of the LED signals.		
	Screen blanking utility installed or energy saver features enabled.	Press any key or click the mouse button, and, if set, enter your password.		
	System ROM is bad; system is running in FailSafe Boot Block mode (indicated by 8 beeps).	Reflash the ROM using a ROMPaq diskette.		
	Fixed-sync monitor will not sync at the resolution chosen.	Be sure that the monitor can accept the same horizontal scan rate as the resolution chosen.		
	Computer is in mode.	Press the power button to resume from mode.		
The display works properly during the POST but goes blank when the operating system starts.	Monitor settings in the workstation are not compatible with the monitor.	1. Restart the workstation and press <b>F8</b> during startup when you see <b>Press F8</b> in the bottom-right corner of the screen.		
		2. Using the keyboard arrow keys, select <b>Enable VGA Mode</b> and press <b>Enter</b> .		
		3. In Windows Control Panel, double-click the <b>Display</b> icon and select the <b>Settings</b> tab.		
		4. Use the sliding control to reset the resolution.		
The display works properly during the POST but goes blank when the operating system starts.	The display settings in the operating system are incompatible with your graphics card and monitor.	1. Restart your workstation in VGA mode.		
		2. After the operating system starts, change the display settings to match those supported by your graphics card and monitor.		
		3. Refer to your operating system and graphics card documentation for information on changing display settings.		
Power LED flashes red 6 times, once every second, followed by a 2-second pause, and the workstation beeps 6 times.	Pre-video graphics error.	For systems with a graphics card:		
		1. Reseat the graphics card.		
		2. Replace the graphics card.		
Power LED flashes red 6 times, once every second, followed by a 2-second pause, and the workstation beeps 6 times.	Pre-video graphics error.	3. Replace the system board.		
		Monitor does not function properly when used with energy saver features.	Monitor without energy saver capabilities is being used with energy saver features enabled.	Disable monitor energy saver feature.
		Dim character s.	The brightness and contrast controls are not set properly.	Adjust the monitor brightness and contrast controls.
Cables are not properly connected.	Verify that the graphics cable is securely connected to the graphics card and the monitor.			

**Table 5-7** Display problems (continued)

Problem	Cause	Solution
Blurry video or requested resolution cannot be set.	If the graphics controller was upgraded, the correct video drivers might not be loaded.	Install the video drivers included in the upgrade kit.
	Monitor is not capable of displaying requested resolution.	Change requested resolution.
The picture is broken up, rolls, jitters, or flashes.	The monitor connections might be incomplete, or the monitor might be incorrectly adjusted.	<ol style="list-style-type: none"> <li>1. Be sure the monitor cable is securely connected to the workstation.</li> <li>2. In a 2-monitor system or if another monitor is in close proximity, be sure the monitors are not interfering with each other's electromagnetic field by moving them apart.</li> <li>3. Fluorescent lights or fans might be too close to the monitor.</li> </ol>
	Monitor must be degaussed.	Degauss the monitor.
Vibrating or rattling noise coming from inside a CRT monitor when powered on.	Monitor degaussing coil has been activated.	None. It is normal for the degaussing coil to be activated when the monitor is powered on.
Clicking noise coming from inside a CRT monitor.	Electronic relays have been activated inside the monitor.	None. It is normal for some monitors to make a clicking noise when turned on and off, when going in and out of Standby mode, and when changing resolutions.
High pitched noise coming from inside a flat-panel monitor.	Brightness and contrast settings are too high.	Lower brightness and contrast settings.
Fuzzy focus; streaking, ghosting, or shadowing effects; horizontal scrolling lines; faint vertical bars; or unable to center the picture on the screen. (Flat-panel monitors using an analog VGA input connection only.)	Flat-panel monitor's internal digital conversion circuits might be unable to correctly interpret the output synchronization of the graphic card.	<ol style="list-style-type: none"> <li>1. Select the monitor's <b>Auto-Adjustment</b> option in the monitor's on-screen display menu.</li> <li>2. Manually synchronize the Clock and Clock Phase on-screen display functions. Download SoftPac SP20930 or SP22333, depending on the monitor, to assist with the synchronization.</li> </ol>
Certain typed symbols do not appear correctly.	The font you are using does not support that particular symbol.	Use the Character Map to locate the and select the appropriate symbol. Click <b>Start&gt;All Programs&gt;Accessories&gt;System Tools&gt;Character Map</b> . You can copy the symbol from the Character Map into a document.

## Solving audio problems

**Table 5-8** Audio problems

Problem	Cause	Solution
Sound does not come out of the speaker or headphones.	Software volume control is turned down.	Double-click the <b>Speaker</b> icon on the taskbar and use the volume slider to adjust the volume.
	The external speakers are not turned on.	Turn on the external speakers.
	External speakers plugged into the wrong audio jack.	See the sound card documentation for proper speaker connection.
	Audio cable not connected.	Connect audio cable between CD or DVD-ROM drive and the system board.



**Table 5-8** Audio problems (continued)

Problem	Cause	Solution
	Digital CD audio is not enabled.	Enable digital CD audio: <ol style="list-style-type: none"> <li>From the Control Panel, select <b>System</b>.</li> <li>On the Hardware tab, click the <b>Device Manager</b> button.</li> <li>Right-click the <b>CD/DVD</b> device and select <b>Properties</b>.</li> <li>On the Properties tab, be sure <b>Enable digital CD audio for this CD-ROM device</b> is selected.</li> </ol>
	Headphones or devices connected to the line-out connector mute the internal speaker.	Turn on and use headphones or external speakers, if connected, or disconnect headphones or external speakers.
	Volume is muted.	<ol style="list-style-type: none"> <li>From the Control Panel program, click <b>Sound, Speech and Audio Devices</b>, then click <b>Sounds and Audio Devices</b>.</li> <li>Click the <b>Mute</b> checkbox to remove the checkmark from the box.</li> </ol>
	Computer is in Standby mode.	Press the power button to resume from Standby mode.
Noise or no sound comes out of the speakers or headphones.		<ol style="list-style-type: none"> <li>If using digital speakers that have a stereo jack and want the system to auto-switch to digital, use a stereo-to-mono adapter to properly engage the auto-sense feature or use the multimedia device properties to manually switch the audio signal from analog to digital.</li> <li>If the headphones have a mono jack, use the multimedia device properties to switch the system to analog out.</li> </ol>
 <b>NOTE</b> If you set digital as the <b>Output Mode</b> , the internal speaker and external analog speakers will no longer output audio until you switch back to an auto-sense or analog mode.  If you set analog as the <b>Output Mode</b> , external digital speakers will not function until you change the output mode back to an auto-sense or digital mode.		
The sound occurs intermittently.	Processor resources are being used by other open applications.	Shut down all open processor-intensive applications.
Workstation appears to be locked up while recording audio.	The hard disk might be full.	<ol style="list-style-type: none"> <li>Before recording, be sure there is enough free space on the hard disk.</li> <li>Try recording the audio file in a compressed format.</li> </ol>

## Solving printer problems

**Table 5-9** Printer problems

Problem	Cause	Solution
Printer does not print.	Printer is not turned on and online.	Turn the printer on and be sure it is online.

**Table 5-9** Printer problems (continued)

Problem	Cause	Solution
	The correct printer driver for the application is not installed.	<ol style="list-style-type: none"> <li>1. Install the correct printer driver for the application.</li> <li>2. Try printing using the MS-DOS command:  <b>DIR C:\&gt; [printer port]</b>  where <b>[printer port]</b> is the address of the printer being used. If the printer works, reload the printer driver.</li> </ol>
	If you are on a network, you might not have made the connection to the printer.	Make the proper network connections to the printer.
	Printer might have failed.	Run printer self-test.
Printer does not turn on.	The cables might not be connected properly.	Reconnect all cables.
Printer prints garbled information.	The correct printer driver is not installed.	Install the correct printer driver for the application.
	The cables might not be connected properly.	Reconnect all cables.
	Printer memory might be overloaded.	Reset the printer by turning it off for one minute, then turn it back on.
Printer is offline.	The printer might be out of paper.	<ol style="list-style-type: none"> <li>1. Verify the paper tray and refill it if it is empty.</li> <li>2. Select online.</li> </ol>

## Solving keyboard and mouse problems

**Table 5-10** Keyboard and mouse problems

Problem	Cause	Solution
Keyboard commands and typing are not recognized by the workstation.	Keyboard connector is not properly connected.	<ol style="list-style-type: none"> <li>1. Power off the workstation.</li> <li>2. Reconnect the keyboard to the back of the workstation and restart the workstation.</li> </ol>
	Program in use has stopped responding to commands.	Shut down the workstation using the mouse, and then restart the workstation.
	Keyboard needs repairs.	Replace the keyboard.
	Keyboard key is stuck down.	Remove any debris from the keyboard.
	Workstation is in mode.	Press the power button to resume from mode.
Cursor will not move using the arrow keys on the keypad.	The <b>Num Lock</b> key might be on.	Press the <b>Num Lock</b> key. The <b>Num Lock</b> light should not be on if you want to use the arrow keys. The <b>Num Lock</b> key can be disabled (or enabled) in Computer Setup.
Mouse does not respond to movement or is too slow.	Mouse connector is not properly plugged into the back of the workstation.	<ol style="list-style-type: none"> <li>1. Shut down the workstation using the keyboard.</li> <li>2. Plug the mouse connector into the PS/2 mouse connector slot in the workstation, and restart the workstation.</li> </ol>

**Table 5-10** Keyboard and mouse problems (continued)

Problem	Cause	Solution
	Program in use has stopped responding to commands.	Shut down the workstation using the keyboard and then restart the workstation.
	Mouse needs repairs.	Replace the mouse.
	Workstation is in Standby mode.	Press the power button to resume from Standby mode.
Mouse will only move vertically or horizontally, or movement is jerky.	Mouse roller ball is dirty.	Remove roller ball cover from the bottom of the mouse and clean it. Then, replace cover.

## Solving front panel component problems

If you are experiencing problems with one of the front panel ports, you might be able to try your device in the corresponding port on the back side of the computer. If this does not fix the problem or you must use the front panel ports, continue troubleshooting.

Some problems in this section are also discussed in other troubleshooting suggestions in this chapter.

**Table 5-11** Front panel component problems

Problem	Cause	Solution
A USB device, headphone, or microphone is not recognized by the workstation.	The device is not properly connected.	<ol style="list-style-type: none"> <li>1. Power off the workstation.</li> <li>2. Reconnect the device to the front of the workstation and restart the workstation.</li> </ol>
	The device does not have power.	If the USB device requires AC power, be sure one end is connected to the device and one end is connected to a live outlet.
	The correct device driver is not installed.	<ol style="list-style-type: none"> <li>1. Install the correct driver for the device.</li> <li>2. You might need to reboot the workstation.</li> </ol>
	The cable from the device to the computer does not work.	<ol style="list-style-type: none"> <li>1. If possible, replace the cable.</li> <li>2. Restart the workstation.</li> </ol>
	The device is not working.	<ol style="list-style-type: none"> <li>1. Replace the device.</li> <li>2. Restart the workstation.</li> </ol>
A USB, audio, or IEEE-1394 devices is not working.	The internal cables might not be connected to the system board or the PCI card.	<ol style="list-style-type: none"> <li>1. Power off the workstation.</li> <li>2. Connect the cables correctly.</li> </ol>
A device in the IEEE-1394 port is not responsive.	Cables of new external device are loose, or power cables are unplugged.	Be sure that all cables are properly and securely connected.
	The power switch on the device is not turned on.	Power off the workstation, power on the external device, then power on the workstation to integrate the device with the workstation system.
The IEEE-1394 port is not active.	The port is not there because it was not purchased with the system.	You can buy an IEEE 1394 PCI adapter card. Contact an HP seller.

## Solving hardware installation problems

You might need to reconfigure the workstation when you add or remove hardware, such as an additional diskette drive. If you install a PnP (positive-negative-positive) device, Windows 2000 and Windows XP automatically recognize the device and configure the workstation. If you install a non-PnP device, you must reconfigure the workstation after completing installation of the new hardware.

**Table 5-12** Hardware installation problems

Problem	Cause	Solution
A new device is not recognized as part of the system.	Device is not seated or connected properly.	Be sure that the device is properly and securely connected and that pins in the connector are not bent down.
	Cables of new external device are loose, or power cables are unplugged.	Be sure that all cables are properly and securely connected and that pins in the cable or connector are not bent down.
	Power switch of new external device is not turned on.	Power off the workstation, power on the external device, then power on the workstation to integrate the device with the workstation system.
	When the system advised you of changes to the configuration, you did not accept them.	Reboot the workstation and follow the instructions for accepting the changes.
Workstation will not start.	A PnP board might not automatically configure when added if the default configuration conflicts with other devices.	Use Windows XP Device Manager to deselect the automatic settings for the board and choose a basic configuration that does not cause a resource conflict. You can also use Computer Setup to reconfigure or disable devices to resolve the resource conflict.
	Device hardware is not properly jumpered or otherwise configured.	Read the device-specific configuration information and check for incorrect settings or conflicts with other devices already installed in the system.
Workstation will not start.	Wrong memory modules were used in the upgrade, or memory modules were installed in the wrong location.	<ol style="list-style-type: none"> <li>1. Review the documentation that came with the system to determine if you are using the correct memory modules and to verify the proper installation.</li> <li>2. Observe the beeps and LEDs on the front of the workstation. Refer to <a href="#">POST and error messages on page 128</a> to determine possible causes.</li> </ol>
	PCI Express power cable might be plugged into the wrong connector on the system board.	Connect the auxiliary PCI Express power cable to the PCI Express card.
Power LED flashes red 5 times, once every second, followed by a 2-second pause, and the workstation beeps 5 times.	Memory is installed incorrectly or is bad.	<ol style="list-style-type: none"> <li>1. Reseat DIMMs.</li> <li>2. Replace DIMMs one at a time to isolate the faulty module.</li> <li>3. Replace third-party memory with HP memory. Replace the system board.</li> </ol>
Power LED flashes red 6 times, once every second, followed by a 2-second pause, and the workstation beeps 6 times.	Video card is not seated properly or is bad, or system board is bad.	<p>For systems with a graphic card:</p> <ol style="list-style-type: none"> <li>1. Reseat the graphics card.</li> <li>2. Replace the graphics card.</li> <li>3. Replace the system board.</li> </ol>

## Solving network problems

These guidelines do not discuss the process of debugging the network cabling.

**Table 5-13** Network problems

Problem	Cause	Solution
Wake-on-LAN feature is not functioning.	Wake-on-LAN is not enabled.	Use the Network control application to enable Wake-on-LAN.
Network driver does not detect network controller.	Network controller is disabled.	Run Computer Setup and enable network controller.
	Incorrect network driver.	Verify the network controller documentation for the correct driver or obtain the latest driver from the manufacturer's website.
Network status link light does not illuminate or it never flashes.	No active network is detected.	Verify cabling and network equipment for proper connection.
The network status light should flash when there is network activity.	Network controller is not set up properly.	Use the Network control application to verify that the device is working properly.
	Network driver is not properly loaded.	Reinstall network drivers.
	System cannot auto-sense the network.	Disable auto-sensing capabilities and force the system into the correct operating mode.
Diagnostics reports a failure.	The cable is not securely connected.	Be sure that both ends of the data cable are securely connected.
	The cable is attached to the incorrect connector.	Be sure that the cable is attached to the correct connector.
	There is a problem with the cable or a device at the other end of the cable.	Be sure that the cable and device at the other end are operating correctly.
	Network controller interrupt is shared with an expansion board.	Under the Computer Setup <b>Advanced</b> menu, change the resource settings for the board.
Diagnostics passes, but the workstation does not communicate with the network.	The network controller is defective.	Replace the NIC.
	Network drivers are not loaded, or driver parameters do not match current configuration.	<ol style="list-style-type: none"> <li>1. Be sure the network drivers are loaded and that the driver parameters match the configuration of the network controller.</li> <li>2. Be sure the correct network client and protocol is installed.</li> </ol>
	The network controller is not configured for this workstation.	Double-click the <b>Network</b> icon in the Control Panel and configure the network controller.
Network controller stopped working when an expansion board was added to the workstation.	Network controller interrupt is shared with an expansion board.	Under the Computer Setup <b>Advanced</b> menu, change the resource settings for the board.
	The network controller requires drivers.	Verify that the drivers were not accidentally deleted when the drivers for a new expansion board were installed.

**Table 5-13** Network problems (continued)

Problem	Cause	Solution
	The expansion board installed is a network card and conflicts with the embedded network card.	Under the Computer Setup <b>Advanced</b> menu, change the resource settings for the board.
Network controller stops working without apparent cause.	The files containing the network drivers are corrupted.	Reinstall the network drivers, using the <i>Restore Plus!</i> CD.
	The cable is not securely connected.	Be sure that both ends of the cable are securely attached to the correct devices.
	The network controller is defective.	Replace the NIC.
New network card will not boot.	New network card might be defective or might not meet industry-standard specifications.	Install a working, industry-standard NIC, or change the boot sequence to boot from another source.
Cannot connect to network server when attempting remote system installation.	The network controller is not configured properly.	Verify network connectivity, that a DHCP Server is present, and that the Remote System Installation Server contains the NIC drivers for your NIC.
System setup utility reports unprogrammed EEPROM.	Unprogrammed EEPROM.	Flash the ROM.

## Solving memory problems



**CAUTION** For those systems that support ECC memory, HP does not support mixing ECC and non-ECC memory. Otherwise, the system will not boot the operating system.

**Table 5-14** Memory problems

Problem	Cause	Solution
System will not boot or does not function properly after installing additional memory modules.	Memory module is not the correct type or speed or the new memory module is not seated properly.	Replace module with the correct industry-standard device for the workstation.  On some models, ECC and non-ECC memory modules cannot be mixed.
Out of memory error.	Memory configuration might not be set up correctly.	Use the Device Manager to verify memory configuration.
	You have run out of memory to run the application.	Verify the application documentation to determine the memory requirements.
Memory count during POST is wrong.	The memory modules might not be installed correctly.	Verify that the memory modules have been installed correctly and that proper modules are used.
Insufficient memory error during operation.	Too many Terminate and Stay Resident programs (TSRs) are installed.	Delete any TSRs that you do not need.
	You have run out of memory for the application.	Verify the memory requirements for the application or add more memory to the workstation.
Power LED flashes red 5 times, once every second, followed by a 2-second pause, and the workstation beeps 5 times.	Memory is installed incorrectly or is bad.	<ol style="list-style-type: none"> <li>1. Reseat DIMMs.</li> <li>2. Replace DIMMs one at a time to isolate the faulty module.</li> </ol>

**Table 5-14** Memory problems (continued)

Problem	Cause	Solution
		<ol style="list-style-type: none"> <li>3. Replace third-party memory with HP memory.</li> <li>4. Replace the system board.</li> </ol>

## Solving processor problems

**Table 5-15** Processor problems

Problem	Cause	Solution
Poor performance is experienced.	Processor is hot.	<ol style="list-style-type: none"> <li>1. Be sure the airflow to the workstation is not blocked.</li> <li>2. Be sure the fans are connected and working properly (some fans only operate when needed).</li> <li>3. Be sure the CPU heatsink is installed properly.</li> </ol>
Power LED is red and stays on.	Processor is not seated properly or not installed.	<ol style="list-style-type: none"> <li>1. Verify that the processor is present.</li> <li>2. Reseat the processor.</li> </ol>

## Solving CD-ROM and DVD problems

**Table 5-16** CD-ROM and DVD problems

Problem	Cause	Solution
System will not boot from CD-ROM or DVD drive.	The CD-ROM or DVD boot is not enabled through the Computer Setup utility.	Run the Computer Setup utility and enable booting to removable media and verify boot order settings.
	Non-bootable CD in drive.	Try a bootable CD in the drive.
CD-ROM or DVD devices are not detected or driver is not loaded.	Drive is not connected properly or not properly configured.	<ol style="list-style-type: none"> <li>1. Reconnect power and data cables to the drive.</li> <li>2. Install correct device driver.</li> </ol>
Movie will not play in the DVD drive.	Movie might be regionalized for a different country.	See the documentation that came with the DVD drive.
	Decoder software is not installed.	Install decoder software.
Cannot eject CD (tray-load unit).	Disc not properly seated in the drive.	<ol style="list-style-type: none"> <li>1. Power off the workstation and insert a thin metal rod into the emergency eject hole and push firmly.</li> <li>2. Slowly pull the tray out from the drive until the tray is fully extended, and remove the disc.</li> </ol>
CD-ROM, CD-RW, DVD-ROM, or DVD-R/RW drive cannot read a disc or takes too long to start.	CD has been inserted upside down.	Reinsert the CD with the label facing up.
	The DVD-ROM drive takes longer to start because it has to determine the type of media played, such as audio or video.	Wait at least 30 seconds to let the DVD-ROM drive determine the type of media being played. If the disc still does not start, read the other solutions listed for this topic.
	CD or DVD disc is dirty.	Clean CD or DVD with a CD cleaning kit.

**Table 5-16** CD-ROM and DVD problems (continued)

Problem	Cause	Solution
	Windows does not detect the CD-ROM or DVD-ROM drive.	<ol style="list-style-type: none"> <li>1. Use Device Manager to remove or uninstall the device in question.</li> <li>2. Restart the workstation and let Windows detect the device.</li> </ol>
Recording audio CDs is difficult or impossible.	Wrong or poor quality media type.	<ol style="list-style-type: none"> <li>1. Use a slower recording speed.</li> <li>2. Verify that you are using the correct media for the drive.</li> <li>3. Try a different brand of media. Quality varies widely between manufacturers.</li> </ol>

## Solving Internet access problems

**Table 5-17** Internet access problems

Problem	Cause	Solution
Unable to connect to the Internet.	Internet Service Provider (ISP) account is not set up properly.	Verify Internet settings or contact the ISP for assistance.
	Modem is not set up properly.	Reconnect the modem. Verify the connections are correct using the quick setup documentation.
	Web browser is not set up properly.	Verify that the web browser is installed and set up to work with your ISP.
	Cable/DSL modem is not plugged in.	Plug in cable/DSL modem. You should see a "power" LED on the front of the cable/DSL modem.
	Cable/DSL service is not available or has been interrupted because of bad weather.	Try connecting to the Internet at a later time or contact your ISP. (If the cable/DSL service is connected, the "cable" LED light on the front of the cable/DSL modem will be on.)
	The CAT5 10/100/1000 cable is disconnected.	Connect the CAT5 10/100/1000 cable between the cable modem and the workstation's RJ-45 connector. (If the connection is good, the "PC" LED on the front of the cable/DSL modem will be on.)
	IP address is not configured properly.	Contact the ISP for the correct IP address.
	Cookies are corrupted.	<ol style="list-style-type: none"> <li>1. Select <b>Start&gt;Control Panel</b>.</li> <li>2. Double-click <b>Internet Options</b>.</li> <li>3. On the General tab, click the <b>Delete Cookies</b> button.</li> </ol>
Cannot automatically launch Internet programs.	You must log on to the ISP before some programs will start.	Log on to the ISP and launch the desired program.
Internet takes too long to download websites.	Modem is not set up properly.	<ol style="list-style-type: none"> <li>1. Select <b>Start&gt;Control Panel</b>.</li> <li>2. Continue with step #2.</li> <li>3. Double-click <b>System</b>. Click the <b>Hardware</b> tab.</li> </ol>



**Table 5-17** Internet access problems (continued)

Problem	Cause	Solution
		<ol style="list-style-type: none"><li data-bbox="938 226 1485 279">4. In the Device Manager area, click the <b>Device Manager</b> button.</li><li data-bbox="938 302 1485 323">5. Double-click <b>Ports</b> (COM &amp; LPT).</li><li data-bbox="938 346 1485 399">6. Right-click the COM port your modem uses, then click <b>Properties</b>.</li><li data-bbox="938 422 1485 474">7. Under Device status, verify that the modem is working properly.</li><li data-bbox="938 497 1485 518">8. Under Device usage, verify the modem is enabled.</li><li data-bbox="938 541 1485 594">9. If there are further problems, click the <b>Troubleshoot</b> button and follow the on-screen instructions.</li></ol>

# POST and error messages

POST is a program run at startup that initializes and runs some tests on installed hardware. An audible and/or visual message occurs if the POST encounters a problem. POST checks the following items to ensure that the workstation system is functioning properly:

- Keyboard
- Memory modules
- Diskette drives
- All SATA and SAS mass storage devices
- Processors
- Controllers



**NOTE** If the power-on password is set, a key icon appears on the screen while POST is running. You must enter the password before continuing.

**Table 5-18** POST error messages

Screen message	Probable cause	Recommended action
101—Option ROM Error	System ROM checksum.	Verify the correct ROM: <ol style="list-style-type: none"><li>1. Flash the ROM if needed.</li><li>2. If an expansion card was recently added, remove it and see if the problem remains.</li><li>3. Clear CMOS. If the message disappears, there might be a problem with the expansion card</li><li>4. Replace the system board.</li></ol>
102—System Board Failure	DMA, timers, etc.	<ol style="list-style-type: none"><li>1. Clear CMOS.</li><li>2. Remove expansion boards.</li><li>3. Replace the system board.</li></ol>
103—System Board Failure	DMA, timers, etc.	<ol style="list-style-type: none"><li>1. Clear CMOS.</li><li>2. Remove expansion boards.</li><li>3. Replace the system board.</li></ol>
110—Out of Memory for Option ROMs	Option ROM for a device was unable to run due to memory constraints.	Run Computer Setup and enable the <b>ACPO/USB Buffers at Top of Memory</b> under the <b>Advanced&gt;Power-On</b> option.
150—SafePost Active	A PCI expansion card is not responding.	<ol style="list-style-type: none"><li>1. Restart the workstation.</li><li>2. Disable <b>SafePost</b>.</li><li>3. If the expansion card does not respond, replace the card.</li></ol>

**Table 5-18** POST error messages (continued)

Screen message	Probable cause	Recommended action
162—System Options Not Set	Configuration incorrect. RTC battery might need to be replaced.	<ol style="list-style-type: none"> <li>1. Run Computer Setup (F10 Setup).</li> <li>2. Set the date and time under Control Panel or in F10 Setup depending on the operating system.</li> <li>3. If the problem persists, replace the RTC battery.</li> </ol>
163—Time and Date Not Set	<p>Invalid time or date in configuration memory.</p> <p>RTC battery might need to be replaced.</p> <p>CMOS jumper might not be properly installed.</p>	<ol style="list-style-type: none"> <li>1. Set the date and time under Control Panel or in F10 Setup depending on the operating system.</li> <li>2. If the problem persists, replace the RTC battery.</li> </ol>
164—Memory Size Error	Memory configuration is incorrect.	<ol style="list-style-type: none"> <li>1. Run Computer Setup (F10 Setup) or Windows utilities.</li> <li>2. Be sure memory modules (if any) are installed properly.</li> <li>3. If third-party memory has been added, test using HP memory only.</li> <li>4. Verify proper memory module type.</li> </ol>
183—Invalid Processor Jumper Setting	System board jumper improperly set.	Reset system board jumpers to match processor and bus speeds (select models).
201—Memory Error	RAM failure.	<ol style="list-style-type: none"> <li>1. Run Computer Setup (F10 Setup) or Windows utilities.</li> <li>2. Be sure that memory and continuity modules are installed correctly.</li> <li>3. Verify proper memory module type.</li> <li>4. Remove and replace memory modules one at a time to isolate faulty module.</li> <li>5. Replace the faulty memory modules.</li> <li>6. If error persists after replacing memory modules, replace the system board.</li> </ol>
202—Memory Type Mismatch	Memory modules do not match each other.	Replace memory modules with matched sets.
207—ECC Corrected Single Bit Errors in Memory Socket(s) y,y	Single-bit ECC error.	<ol style="list-style-type: none"> <li>1. Verify proper memory module type.</li> <li>2. Insert the DIMM in another memory socket.</li> <li>3. Replace memory module if problem persists.</li> </ol>
212—Failed Processor	Processor has failed to initialize.	<ol style="list-style-type: none"> <li>1. Reseat the processor in its socket.</li> <li>2. If the processor does not respond, replace it.</li> </ol>
213—Incompatible memory Module in memory Socket(s) X,X, X	A memory module in memory socket identified in the error message is missing critical SPD information or is incompatible with the chipset.	<ol style="list-style-type: none"> <li>1. Verify proper memory module type.</li> <li>2. Insert the DIMM in another memory socket.</li> <li>3. Replace memory with a module conforming to the SPD standard.</li> </ol>

**Table 5-18** POST error messages (continued)

Screen message	Probable cause	Recommended action
214—DIMM Configuration Warning	DIMMs not installed correctly (not paired correctly).	See the illustration on the side access panel for the correct memory configurations and reseal the DIMMs accordingly.
215—Memory Mismatch Warning	There are one or more mismatched pairs of DIMMs between channel A and channel B. Some memory has been disabled. Install matching pairs or remove the mismatched DIMMs from channel B.	See the illustration on the side access panel for the correct memory configurations and reseal the DIMMs accordingly.
216—Memory Size Exceeds Maximum Supported	The amount of memory installed exceeds that supported by the hardware.	<ol style="list-style-type: none"> <li>1. Verify how much memory your system can support.</li> <li>2. Remove the excessive memory.</li> </ol>
219—ECC Memory Module Detected.	ECC modules not supported on this platform.	Remove the ECC module.
301—Keyboard Error	Keyboard failure.	<ol style="list-style-type: none"> <li>1. Reconnect the keyboard with workstation powered off.</li> <li>2. Check the connector for bent or missing pins.</li> <li>3. Be sure that none of the keys are pressed.</li> <li>4. Replace the keyboard.</li> </ol>
303—Keyboard Controller Error	I/O board keyboard controller.	<ol style="list-style-type: none"> <li>1. Reconnect keyboard with workstation turned off.</li> <li>2. Replace the system board.</li> </ol>
304—Keyboard or System Unit Error	Keyboard failure.	<ol style="list-style-type: none"> <li>1. Reconnect the keyboard with workstation turned off.</li> <li>2. Be sure that none of the keys are pressed.</li> <li>3. Replace keyboard.</li> <li>4. Replace system board.</li> </ol>
401—Parallel Port 1 Address Assignment Conflict	IRQ address conflicts with another device.	Reset the IRQ.
402—Parallel Port 2 Address Assignment Conflict	IRQ address conflicts with another device.	Reset the IRQ.
403—Parallel Port 3 Address Assignment Conflict	IRQ address conflicts with another device.	Reset the IRQ.
404—Parallel Port Address Conflict Detected	Both external and internal ports are assigned to parallel port X.	<ol style="list-style-type: none"> <li>1. Remove any parallel expansion cards.</li> <li>2. Clear CMOS.</li> <li>3. Reconfigure card resources and run Computer Setup (F10 Setup).</li> </ol>
410—Audio Interrupt Conflict	IRQ address conflicts with another device.	Reset the IRQ.
411—Network Interface Card Interrupt Conflict	IRQ address conflicts with another device.	Reset the IRQ.

**Table 5-18** POST error messages (continued)

Screen message	Probable cause	Recommended action
501—Display Adapter Failure	Graphics display controller.	<ol style="list-style-type: none"> <li>1. Reseat the graphics card (if applicable).</li> <li>2. Clear CMOS.</li> <li>3. Verify that the monitor is attached and turned on.</li> </ol>
510—Splash Screen image corrupted	Splash Screen image has errors.	Install latest version of ROMPaq to restore image.
511—CPU, CPUA, or CPUB Fan not detected	Fan is not connected or might have malfunctioned.	<ol style="list-style-type: none"> <li>1. Reseat the fan cable.</li> <li>2. Reseat the fan.</li> <li>3. Replace the fan.</li> </ol>
512—Chassis, rear chassis, or front chassis fan not detected	Fan is not connected, might have malfunctioned.	<ol style="list-style-type: none"> <li>1. Reseat the chassis, rear chassis, or front chassis fan cable.</li> <li>2. Reseat the chassis, rear chassis, or front chassis fan.</li> <li>3. Replace the chassis, rear chassis, or front chassis fan.</li> </ol>
514—CPU or Chassis Fan not detected	CPU fan is not connected or might have malfunctioned.	<ol style="list-style-type: none"> <li>1. Reseat the CPU or chassis fan.</li> <li>2. Replace the CPU or chassis fan.</li> </ol>
601—Diskette Controller Error	Diskette controller circuitry or diskette drive circuitry incorrect.	<ol style="list-style-type: none"> <li>1. Run Computer Setup (F10 Setup).</li> <li>2. Verify and replace cables.</li> <li>3. Clear CMOS.</li> <li>4. Replace diskette drive.</li> <li>5. Replace the system board.</li> </ol>
605—Diskette Drive Type Error	Mismatch in drive type.	<ol style="list-style-type: none"> <li>1. Run Computer Setup (F10 Setup).</li> <li>2. Disconnect any other diskette controller devices (tape drives).</li> <li>3. Clear CMOS.</li> </ol>
610—External Storage Device Failure	External tape drive not connected.	Reinstall tape drive or press <b>F1</b> and allow system to reconfigure without the drive.
611—Primary Diskette Port Address Assignment Conflict	Configuration error.	<ol style="list-style-type: none"> <li>1. Run Computer Setup (F10 Setup).</li> <li>2. Remove expansion cards.</li> <li>3. Clear CMOS.</li> </ol>
912—Computer Cover Has Been Removed Since Last System Start Up	N/A	No action required.
914—Hood Lock Coil is not Connected	Hood lock mechanism is missing or not connected.	<ol style="list-style-type: none"> <li>1. Reconnect or replace hood locking mechanism.</li> <li>2. Reseat or replace hood locking mechanism cable.</li> </ol>
916—Power Button Not Connected	The power button is not connected.	Connect power button.

**Table 5-18** POST error messages (continued)

Screen message	Probable cause	Recommended action
917—Front Audio Not Connected	The front audio cable is not connected.	Connect front audio cable.
918—Front USB Not Connected	Front USB is not connected.	Connect front USB cable.
919—MultiBay Riser Not Connected	MultiBay riser is not connected.	Connect MultiBay riser.
920—Fan Command 2 Pin Connector from Power Supply Not Connected	The 2-pin fan connector from the power supply is not connected.	Connect 2-pin fan connector.
940—Extended ROM signature not found	The signature at the start of the ROM flash is missing. Your firmware (BIOS) is incomplete.	Run ROMPaq again.
960—CPU Overtemp occurred	The ambient temperature could exceed operating limits (maximum=95°F), or there are obstructions to airflow, including dust build up.	<ol style="list-style-type: none"> <li>1. Be sure you are not operating the system in an environment that exceeds 95°F.</li> <li>2. Disconnect power and open the access panel.</li> <li>3. Verify that cables are not blocking CPU heatsink fans or front fan, if installed.</li> <li>4. Verify that there is not excessive dust on major components.</li> <li>5. If airflow is acceptable and there is not excessive dust, the thermal sensing circuitry has failed on the processors or on the system board. You must replace the processors and/or the system board.</li> </ol>
1151—Serial Port 1 Address Conflict Detected	Both external and internal serial ports are assigned to COM1.	<ol style="list-style-type: none"> <li>1. Remove any Comm port expansion cards.</li> <li>2. Clear CMOS.</li> <li>3. Reconfigure card resources and run Computer Setup (F10 Setup).</li> <li>4. Run Computer Setup or Windows utilities.</li> </ol>
1152—Serial Port 2 Address Conflict Detected	Both external and internal serial ports are assigned to COM2.	<ol style="list-style-type: none"> <li>1. Remove any Comm port expansion cards.</li> <li>2. Clear CMOS.</li> <li>3. Reconfigure card resources and run Computer Setup (F10 Setup).</li> <li>4. Run Computer Setup or Windows utilities.</li> </ol>
1155—Serial Port Address Conflict Detected	Both external and internal serial ports are assigned to same IRQ.	<ol style="list-style-type: none"> <li>1. Remove any Comm port expansion cards.</li> <li>2. Clear CMOS.</li> <li>3. Reconfigure card resources and run Computer Setup (F10 Setup).</li> <li>4. Run Computer Setup or Windows utilities.</li> </ol>
1201—System Audio Address Conflict Detected	Device IRQ address conflicts with another device.	Reset the IRQ.
1202—MIDI Port Address Conflict Detected	Device IRQ address conflicts with another device.	Reset the IRQ.

**Table 5-18** POST error messages (continued)

Screen message	Probable cause	Recommended action
1203—Game Port Address Conflict Detected	Device IRQ address conflicts with another device.	Reset the IRQ
1720 SMART Hard Drive Detect Imminent Failure	Hard drive is about to fail. (Some hard drives have a firmware patch that will fix an erroneous error message.)	<ol style="list-style-type: none"> <li>1. Determine if hard drive is giving correct error message.</li> <li>2. Run the Drive Protection System test if applicable.</li> <li>3. Apply firmware patch if applicable (see <a href="http://www.hp.com/support">http://www.hp.com/support</a>).</li> <li>4. Back up contents and replace hard drive.</li> </ol>
1780—Disk 0 Failure	The drive is not installed correctly or has failed.	<ol style="list-style-type: none"> <li>1. Be sure that any jumpers are set correctly, and that power and drive cables are connected, both to the drive and the system board.</li> <li>2. Verify that the cables are the correct cables for your computer model. If this message persists, you might need service for your workstation.</li> </ol>
1781—Disk 1 Failure	The drive is not installed correctly or has failed.	<ol style="list-style-type: none"> <li>1. Be sure that any jumpers are set correctly and that power and drive cables are connected, both to the drive and the system board.</li> <li>2. Verify that the cables are the correct cables for your computer model. If this message persists, you may need service for your workstation.</li> </ol>
1782—Disk Controller Failure	Hard drive circuitry error.	<ol style="list-style-type: none"> <li>1. Run Computer Setup (F10 Setup).</li> <li>2. Clear CMOS.</li> <li>3. Verify cable seating/jumper settings.</li> <li>4. Run hard drive diagnostics.</li> <li>5. Disconnect additional drives.</li> <li>6. Run the Drive Protection System test if available.</li> <li>7. Replace the hard drive.</li> <li>8. Replace the system board.</li> </ol>
1785—Multibay incorrectly installed	No other IDE device may be attached to the same IDE controller.	Attach the MultiBay as device 0 on the secondary IDE controller.
1790—Disk 0 Error	The drive is not installed correctly or has failed.	<ol style="list-style-type: none"> <li>1. Be sure that any jumpers are set correctly and that power and drive cables are connected, both to the drive and the system board.</li> <li>2. Verify that the cables are the correct cables for your computer model. If this message persists, you may need service for your workstation.</li> </ol>
1791—Disk 1 Error	The drive is not installed correctly or has failed.	<ol style="list-style-type: none"> <li>1. Be sure that any jumpers are set correctly and that power and drive cables are connected, both to the drive and the system board.</li> <li>2. Verify that the cables are the correct cables for your computer model. If this message persists, you may need service for your workstation.</li> </ol>

**Table 5-18** POST error messages (continued)

Screen message	Probable cause	Recommended action
1792—Secondary Disk Controller Failure	Hard drive circuitry error.	<ol style="list-style-type: none"> <li>1. Run Computer Setup (F10 Setup).</li> <li>2. Clear CMOS.</li> <li>3. Verify cable seating/jumper settings.</li> <li>4. Run hard drive diagnostics.</li> <li>5. Disconnect additional drives.</li> <li>6. Run the Drive Protection System test if available.</li> <li>7. Replace the hard drive.</li> </ol>
1793—Secondary Controller or Disk Failure	Hard drive circuitry error.	<ol style="list-style-type: none"> <li>1. Run Computer Setup (F10 Setup).</li> <li>2. Clear CMOS.</li> <li>3. Verify cable seating/jumper settings.</li> <li>4. Run hard drive diagnostics.</li> <li>5. Disconnect additional drives.</li> <li>6. Run the Drive Protection System test if available.</li> <li>7. Replace the hard drive.</li> </ol>
1794—Inaccessible devices attached to primary IDE controller	Devices attached to the primary IDE controller are inaccessible while the SATA controller is set to "Replace Primary IDE Controller" in Setup.	<ol style="list-style-type: none"> <li>1. Run Computer Setup (F10 Setup).</li> <li>2. Select <b>Storage &gt; Storage Options</b> and set SATA controller to <b>Add as Separate Controller</b>.</li> </ol>
1800—Temperature Alert	Internal temperature exceeds specification.	<ol style="list-style-type: none"> <li>1. Verify that workstation air vents are not blocked and cooling fan is running.</li> <li>2. Verify processor speed selection.</li> <li>3. Replace the processor.</li> <li>4. Replace the system board.</li> </ol>
1801—Microcode Patch Error	Processor not supported by ROM BIOS.	Upgrade BIOS to proper version.
1802—Processor Not Supported	The system board does not support the processor.	Replace the processor with a compatible one.
1803—BIOS Update Needed for Processor	This BIOS revision does not support the installed processor.	Install the latest BIOS downloaded from <a href="http://www.hp.com">http://www.hp.com</a> .
1998—Master Boot Record has been lost	The previously saved copy of the MBR has been corrupted.	Run Computer Setup and save the MBR of the current bootable disk.
1998—Master Boot Record has been changed	The current MBR does not match the previously saved copy of the MBR.	Use extreme caution. The MBR might have been updated due to normal disk maintenance activities (disk manager, fdisk, or format). Replacing the previously saved MBR in such situations can cause data loss. If certain that the MBR change is unintentional and undesired (for example, due to a virus), run Computer Setup and restore the previously saved MBR copy. Otherwise, run Computer Setup and either disable MBR security or save the MBR of the current bootable disk.



**Table 5-18** POST error messages (continued)

Screen message	Probable cause	Recommended action
Invalid Electronic Serial Number	Electronic serial number has become corrupted.	Run Computer Setup. If Setup already has data in the field or will not allow the serial number to be entered, download from <a href="http://www.hp.com">http://www.hp.com</a> and run the utility SP5572.EXE (SNZERO.EXE).  Run Computer Setup and try to enter serial number under Security, System ID, and save the changes.
ECC Multiple Bit Error Detected in Memory Module	Chipset has detected more than one bad bit in a 64-bit quadword of the memory array.	Replace the memory module.
Parity Check 2	Parity RAM failure.	Run Computer Setup and Diagnostic utilities.



# A Appendix A — SAS devices

# Supported SAS RAID configurations

---



**NOTE** This section does not apply to configuring RAID in the Linux environment. For RAID in the Linux environment, configure SW RAID configurations as provided by Red Hat Enterprise Linux.

---

Before setting up a RAID, the HP xw6400 Workstation requires:

- Up to 3 internal or external SAS hard disk drives
- Internal-to-external cable for external connections
- SAS to SATA data and power converter
- LSI MyStorage Utility for Windows

The following RAID configurations are supported on the HP xw6400 Workstation:

- RAID 0 – Striped disk array
  - Two drives minimum
  - Improved I/O performance
  - No fault tolerance
- RAID 1 — Mirrored disk array
  - Two drive minimum
  - 100% redundancy
  - Can recover from single drive failure
  - Improved read performance
- RAID 1E
  - Three drives minimum
  - Can be an odd number of drives
  - Can always recover from a single drive failure and, in some cases, can recover from two drive failures

## SAS RAID 0 configuration

Follow the steps below to configure an Integrated Striped (IS) volume with the BIOS-based configuration utility. The configuration procedure assumes that the system already has the required disk and disk controllers.

1. On the Main menu screen of the BIOS-based configuration utility, use the arrow keys to select an adapter.
2. Press **Enter** to go to the Adapter Properties screen.
3. On the Adapter Properties screen, use the arrow keys to select **RAID Properties**.
4. Press **Enter** to go to the RAID Properties screen.
5. In the RAID Properties screen, use the arrow keys to select the first disk for the IS volume. Then use the arrow keys to move to the Array Disk column for this disk, and press the **SPACE**, **+**, or **-** key to select **Yes** as the value for this column. If partitions are defined on the selected disk, a message appears warning you that data on the disk will be lost when the striped volume is created. Press the **M** key to migrate, or the **D** key to delete the data on the drive.
6. Repeat the previous step to select up to three more disks for the striped volume.
7. Press the **C** key to create the array once all drives have been chosen, then press **Esc** and select **Save**.

## SAS RAID 1 configuration

Follow the steps below to configure an Integrated Mirroring (IM) volume with the BIOS-based configuration utility. The configuration procedure assumes that the system already has the required disk and disk controllers.

1. On the Main menu screen of the BIOS-based configuration utility, use the arrow keys to select an adapter.
2. Press **Enter** to go to the Adapter Properties screen.
3. On the Adapter Properties screen use the arrow keys to select **RAID Properties**.
4. Press **Enter** to go to the RAID Properties screen. .
5. Chose one of the following options:

To configure a two-disk mirrored volume with an optional hot spare disk:

- In the RAID Properties screen, use the arrow keys to select the primary disk for the IM volume (the disk with the data you want to mirror.)
- Use the arrow keys to move to the Array Disk column for this disk and use the **SPACE** key to select **Yes** as the value. If partitions are defined on the selected disk, a message appears warning you that data on the disk will be lost when the striped volume is created. Press the **M** key to migrate, or the **D** key to delete the data on the drive.
- When the **Keep Data/Erase Disk** message appears, press **F3** to keep the data currently on this disk. The value in the Array Disk column changes to **Primary**.
- Use the arrow keys to select the secondary (mirrored) disk for the IM volume. Select **Yes** as the value for the Array Disk column.

If partitions are defined on this disk, a message warns you that data on the disk will be lost when the mirrored volume is created. Press **Delete** to confirm erasing data from the disk, or press any other key to deselect the disk. Continue with Step 6.

To configure a mirrored volume with three to six disks, or three to five disks with an optional hot spare disk:

- In the RAID Properties screen, use the arrow keys to select the first disk for the IM volume.
- Use the arrow keys to move to the Array Disk column for this disk, and use the **+** and **-** keys to select **Yes** as the value.
- When the **Keep Data/Erase Disk** message appears, press **Delete** to erase the disk.
- Use the arrow keys to select the next disk for the IM volume. Select **Yes** as the value for the Array Disk column.

If partitions are defined on this disk, a message warns you that data on the disk will be lost when the mirrored volume is created. Press **Delete** to confirm erasing data from the disk, or press any other key to deselect the disk.

- Repeat the previous steps to select up to four more disks for the IM volume. If you want to configure a hot spare disk for the volume, you can only select up to three more disks.

6. (Optional) Use the arrow keys to select a hot spare disk for the IM volume. Select **Yes** as the value for the Hot Spare column.
7. When you have selected all disks for the IM volume, press **Esc** and select **Save changes, then exit this menu**. If you do not want to create the IM volume, select **Discard changes, then exit this menu**.

The IM volume exists as soon as you save the changes. The RAID Properties screen now displays the IM volume properties and status.

## SAS RAID 1E configuration

Follow the steps below to configure an Integrated Mirroring Extended (IME) volume with the BIOS-based configuration utility. The configuration procedure assumes that the system already has the required disk and disk controllers.

1. On the Main menu screen of the BIOS-based configuration utility, use the arrow keys to select an adapter.
2. Press **Enter** to go to the Adapter Properties screen.
3. On the Adapter Properties screen use the arrow keys to select **RAID Properties** on the screen.
4. Press **Enter** to go to the RAID Properties screen. Continue with Step 5 to configure a two-disk mirrored volume. Go to Step 6 to configure a mirrored volume with three to six disks.
5. Choose one of the following options:

To configure a two-disk mirrored volume with an optional hot spare disk:

- In the RAID Properties screen, use the arrow keys to select the primary disk for the IME volume (the disk with the data you want to mirror.)
- Use the arrow keys to move to the Array Disk column for this disk and use the **SPACE**, **+**, or **-** key to select **Yes** as the value. If partitions are defined on the selected disk, a message appears warning you that data on the disk will be lost when the striped volume is created. Press the **M** key to migrate, or the **D** key to delete the data on the drive.
- When the **Keep Data/Erase Disk** message appears, press **F3** to keep the data that is currently on this disk. The value in the Array Disk column changes to **Primary**.
- Use the arrow keys to select the secondary (mirrored) disk for the IME volume. Select **Yes** as the value for the Array Disk column.

If partitions are defined on this disk, a message warns you that data on the disk will be lost when the mirrored volume is created. Press **Delete** to confirm erasing data from the disk, or press any other key to deselect the disk. Continue with Step 6.

To configure a mirrored volume with three to six disks, or three to five disks with an optional hot spare disk:

- In the RAID Properties screen, use the arrow keys to select the first disk for the IME volume.
- Use the arrow keys to move to the Array Disk column for this disk, and use the **+** and **-** keys to select **Yes** as the value.
- When the **Keep Data/Erase Disk** message appears, press **Delete** to erase the disk.
- Use the arrow keys to select the next disk for the IME volume. Select **Yes** as the value for the Array Disk column.

If partitions are defined on this disk, a message warns you that data on the disk will be lost when the mirrored volume is created. Press **Delete** to confirm erasing data from the disk, or press any other key to deselect the disk.

- Repeat the previous steps to select up to four more disks for the IME volume. If you want to configure a hot spare disk for the volume, you can only select up to three more disks.



6. (Optional) Use the arrow keys to select a hot spare disk for the IME volume. Select **Yes** as the value for the Hot Spare column.
7. When you have selected all disks for the IME volume, press **Esc** and select **Save changes, then exit this menu**. If you do not want to create the IME volume, select **Discard changes, then exit this menu**.

The IME volume exists as soon as you save the changes. The RAID Properties screen now displays the IME volume properties and status.



# B Appendix B — SATA devices

This appendix describes how to use the Intel Matrix Storage Manager option ROM Configuration Utility to set up and manage SATA RAID volumes.



---

**NOTE** If only a single HDD is attached, the Intel Matrix Storage Manager option ROM will not execute. All associated messages will not be displayed.

The Intel Serial ATA AHCI BIOS always executes when RAID/AHCI is selected for the SATA emulation mode. This BIOS is only used to support serial attached optical drives. When an HDD is attached, the AHCI BIOS properly identifies the HDD that is connected to the appropriate SATA port and displays **Device not supported in this configuration**. This message is expected and does not indicate a problem.

---

## Attaching SATA HDDs

Attach the required number of SATA HDDs for the desired RAID level.

- RAID 0: Two to three HDDs
- RAID 1: Two HDDs
- RAID 5: Three HDDs

# Configuring system BIOS

Configure the system BIOS to enable embedded SATA RAID functionality.

1. Press **F10** to enter the system BIOS setup.
2. Use the arrow keys to highlight the desired language, then press **Enter**.
3. Use the arrows on your keyboard to highlight **Storage>Storage Options**, then press **Enter**.
4. Use the up or down arrow key to highlight **SATA Emulation**.
5. Use the left or right arrow key to select **RAID/AHCI**.
6. Press **F10** to accept the new setting.
7. Use the arrows on your keyboard to highlight **Advanced > Power-On Options**, then press **Enter**.
8. Use the up or down arrow key to highlight **POST Messages**.
9. Use the left or right arrow key to select **Enable**.
10. Press **F10** to accept the new setting.
11. Use the arrow keys to highlight **Advanced>Device Options**, and press **Enter**.
12. Use the up or down arrow key to highlight **SATA RAID Option ROM Download**, and press **Enter**.
13. Use the left or right arrow key to select **Enable**.
14. Press **F10** to accept the new setting.
15. Use the arrows on your keyboard to highlight **File>Save Changes and Exit**, and press **Enter**.
16. Press **F10** when prompted.

## Creating RAID volumes

Use the Intel Matrix Storage Manager option ROM Configuration Utility to create RAID volumes.

1. Press **Ctrl+I** when prompted to enter the Intel Matrix Storage Manager option ROM Configuration Utility.
2. If required, see [Deleting RAID volumes on page 149](#) to make enough physical drives available to create the desired RAID volume.
3. Use the up or down arrow key to highlight **1. Create RAID Volume**, and press **Enter**.
4. Type the desired RAID volume name in the “Name:” field, and press **Tab**.
5. Use the up or down arrow key to select the desired RAID level in the RAID Level: field, then press **Tab**.
6. Press **Enter** to display the Select Disks dialog.
7. Use the up and down arrow keys and Space to mark individual physical disks as members of the volume.
8. Press **Enter** to exit the Select Disks dialog and return to the Create Volume Menu dialog.
9. If appropriate, use the up or down arrow key to select the Strip Size in the Strip Size: field, and press **Tab**.
10. Type the desired volume size in the Capacity: field, and press **Tab**.
11. Press **Enter** to initiate volume creation.
12. When prompted, press **Y** to acknowledge the warning message and create the volume.
13. Return to step 3 to create additional RAID volumes, or use ↑ or ↓ to highlight **4. Exit**, and press **Enter**.
14. Press **Y** when prompted to confirm the exit.

## Deleting RAID volumes

Use the Intel Matrix Storage Manager option ROM Configuration Utility to delete RAID volumes.

1. Use the up or down arrow key to highlight **2. Delete RAID Volume**, and press **Enter**.
2. Use the up or down arrow key to highlight the RAID volume to be deleted, and press **Del**.
3. When prompted, press **Y** to confirm the deletion of the selected RAID volume.
4. Choose one of the following steps:
  - Return to step 1 to delete additional RAID volumes.
  - See [Creating RAID volumes on page 148](#) to create RAID volumes.
  - Use the up or down arrow key to highlight **4. Exit**, and press **Enter**.
  - Use the up or down arrow key to highlight **3. Reset Disks to Non-RAID**, and press **Enter**.
5. Use the up and down arrow keys and Space to mark individual physical disks to be reset.
6. Press **Enter** to complete the selection.
7. When prompted, press **Y** to confirm the reset action.
8. Choose one of the following steps:
  - Return to step 1. to delete additional RAID volumes.
  - See [Creating RAID volumes on page 148](#) to create RAID volumes.
  - Use the up or down arrow key to highlight **4. Exit**, and press **Enter**.





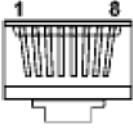

# C Appendix C — Connector pins

# Connector pin descriptions

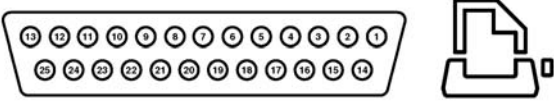
Ethernet connector	Pin	Signal
	1 2 3 4	(+) Transmit Data (-) Transmit Data (+) Receive Data Unused
	5 6 7 8	Unused (-) Receive Data Unused Unused

Parallel connector					
					
Pin	Signal	Pin	Signal	Pin	Signal
1 2 3	Strobe Data Bit 0 Data Bit 1	7 8 9	Data Bit 5 Data Bit 6 Data Bit 7	13 14 15	Select Auto Linefeed Error
4 5 6	Data Bit 2 Data Bit 3 Data Bit 4	10 11 12	Acknowledge Busy Paper End	16 17 18-25	Initialize Printer Select IN Signal Ground

Serial connector	Pin	Signal
	1 2 3	Carrier Detect Receive Data Transmit Data
	4 5 6	Data Terminal Ready Signal Ground Data Set Ready
	7 8 9	Request to Send Clear to Send Ring Indicator

USB connector	Pin	Signal
	1 2 3 4	+5 VDC - Data + Data Ground

IEEE 1394 connector	Pin	Signal
---------------------	-----	--------

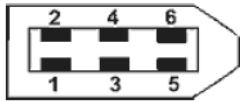

1	power
2	gnd
3	tpb-
4	tpb+
5	tpa-
6	tpa+

#### Microphone connector (1/8 inch)

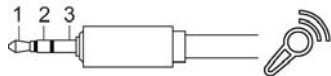

Pin	Signal
1 (Tip)	Audio
2 (Ring)	Power
3 (Shield)	Ground

#### Headphone connector (1/8 inch)

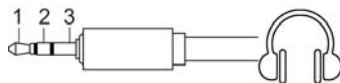

Pin	Signal
1 (Tip)	Audio_Left
2 (Ring)	Audio_Right
3 (Shield)	Ground

#### Line-in audio connector (1/8 inch)

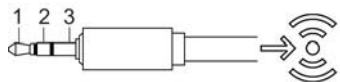

Pin	Signal
1 (Tip)	Audio_In_Left
2 (Ring)	Audio_In_Right
3 (Shield)	Ground

#### Line-out audio connector (1/8 inch)

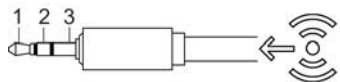

Pin	Signal
1 (Tip)	Audio_Out_Left
2 (Ring)	Audio_Out_Right
3 (Shield)	Ground

### SATA connector

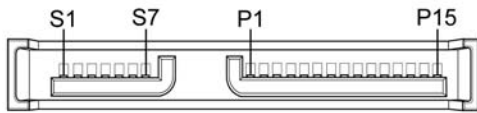

Pin	Signal	Pin	Signal	Pin	Signal
<b>Data Cable</b>		<b>Power Cable</b>		<b>Power Cable</b>	
S1	Ground	P1	3.3-V power	P8	5-V power
S2*	A+	P2	3.3-V power	P9	5-V power
S3*	A-	P3	3.3-V power	P10	Ground
S4	Ground	P4	Ground	P11	Reserved
S5**	B-	P5	Ground	P12	Ground
S6**	B+	P6	Ground	P13	12-V power
S7	Ground	P-7	5-V power	P14	12-V power
				P15	12-V power

\* S2 and S3 differential signal pair

\*\*S5 and S6 differential signal pair

### SAS connector

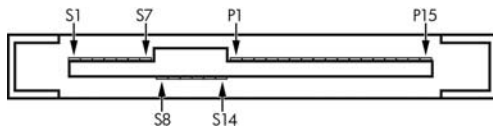

Segment	Pin	Backplane receptacle	Plug and cable receptacles
Primary signal segment	S1	SIGNAL GROUND	
	S2	TP+	RP+
	S3	TP-	RP-
	S4	SIGNAL GROUND	
	S5	RP-	TP-
	S6	RP+	TP+
	S7	SIGNAL GROUND	

## SAS connector

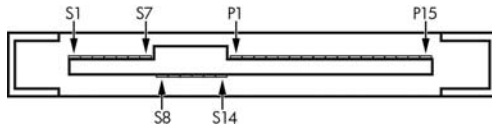

Segment	Pin	Backplane receptacle	Plug and cable receptacles
Secondary signal segment	S8	SIGNAL GROUND	
	S9	TS+	RS+
	S10	TS-	RS-
	S11	SIGNAL GROUND	
	S12	RS-	TS-
	S13	RS+	TS+
	S14	SIGNAL GROUND	
Power segment	P1	$V_{33}^c$	
	P2	$V_{33}^c$	
	P3	$V_{33}^c$ precharge <sup>c</sup>	
	P4	GROUND	
	P5	GROUND	
	P6	GROUND	
	P7	$V_5^c$ precharge <sup>c</sup>	
	P8	$V_5^c$	
	P9	$V_5^c$	
	P10	GROUND	
	P11	READY LED <sup>d</sup>	
	P12	GROUND	
	P13	$V_{12}$ precharge <sup>c</sup>	
	P14	$V_{12}^c$	
	P15	$V_{12}^c$	

### VGA connector

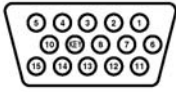

Pin	Signal	Pin	Signal	Pin	Signal
1 2 3	Red Analog Green Analog Blue Analog	6 7 8	Ground Ground Ground	11 12	Monitor ID DDC Serial Data Horizontal Sync
4 5	Monitor ID Ground	9 10	+5V DC Ground	14 15	Vertical Sync DDC Serial Clock

### DVI connector

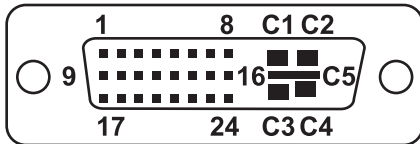

Pin	Signal	Pin	Signal
1	T.M.D.S DATA 2-	16	HOT PLUG DETECT
2	T.M.D.S DATA 2+	17	T.M.D.S DATA 0-
3	T.M.D.S DATA 2/4 SHIELD	18	T.M.D.S DATA 0+
4	T.M.D.S DATA 4-	19	T.M.D.S DATA 0/5 SHIELD
5	T.M.D.S DATA 4+ 2	0	T.M.D.S DATA 5-
6	DDC CLOCK	21	T.M.D.S DATA 5+
7	DDC DATA	22	T.M.D.S CLOCK SHIELD
8	ANALOG VERT. SYNC	23	T.M.D.S CLOCK+
9	T.M.D.S DATA 1-	24	T.M.D.S CLOCK-
10	T.M.D.S DATA 1+		
11	T.M.D.S DATA 1/3 SHIELD	C1	ANALOG RED
12	T.M.D.S DATA 3-	C2	ANALOG GREEN
13	T.M.D.S DATA 3+	C3	ANALOG BLUE
14	+5V POWER	C4	ANALOG HORZ SYNC
15	GND	C5	ANALOG GROUND

### ATA/ATAPI (IDE) standard drive cable connector

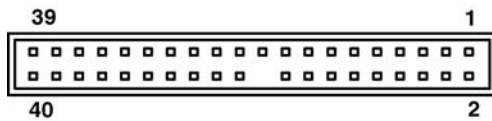

Pin	Signal	Pin	Signal	Pin	Signal
1 2 3	Reset Ground	15 16	DD1 DD14 DD0	29 30	DMAK Ground INTRQ
4 5	DD7 DD8 DD6	17 18	DD15 Ground	31 32	IOCS16 DA1
		19		33	
6 7 8	DD9 DD5 DD10	20 21	(Key) DMARQ	34 35	PDIAG (cable detect) DA0
9 10	DD4 DD11	22 23	Ground DIOW	36 37	DA2 CS1FX CS3FX
		24	Ground	38	
11 12	DD3 DD12 DD2	25 26	DIOR Ground	39 40	DASP Ground
13 14	DD13	27 28	IORDY CSEL		

### 24-Pin Main power connector P1

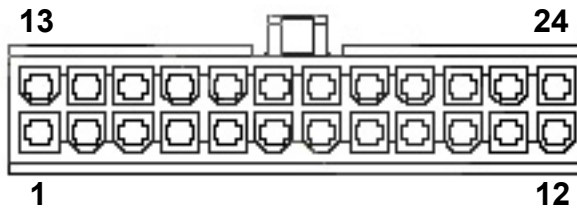

1	+3.3 V	8	POK	14	-12 VL	21	+5 V GND
2	+3.3 V	9	+5 Vaux	15	GND	22	+5 V and
3	GND	10	+12 V-B	16	PS_O N_I		+5 V-Rsense
4	+5 V	11	+12 V-A	17	GND	23	+5 V
5	GND	12	+3.3 V	18	GND	24	GND
6	+5 V	13	+3.3 V	19	GND		
7	GND		+3.3V-Rsense	20	GND		

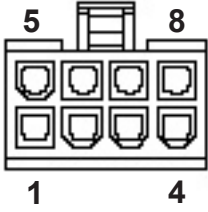

**CAUTION** Be sure you can differentiate between which power cable connects to the PCI Express x16 graphics card and which power cable connects to the system board. These two cables have different pin counts and different colors. The PCI Express power cable has a 6-pin black connector, and the system board power cable has an 8-pin white connector. When power is present, you must **never** connect the PCI Express power cable to the system board. If you do so, the system board may be damaged and your warranty voided. To see a picture of the PCI Express cable and where it must be connected, see [PCI installation on page 79](#) "PCI or PCI Express Installation."

8-Pin power (for CPUs and memory) P3		Pin	Color	Signal
	1	BLK	GND	
	2	BLK	GND	
	3	BLK	GND	
	4	BLK	GND	
	5	WHT	+12VCPU0	
		WHT	+12VCPU0 RSENSE	
	6	WHT	+12VCPU0	
	7	WHT with stripe	+12VCPU1	
8	WHT with stripe	+12VCPU1		

**CAUTION** Be sure you can differentiate between which power cable connects to the PCI Express x16 graphics card and which power cable connects to the system board. These two cables have different pin counts and different colors. The PCI Express power cable has a 6-pin black connector, and the system board power cable has an 8-pin white connector. When power is present, you must **never** connect the PCI Express power cable to the system board. If you do so, the system board may be damaged and your warranty voided. To see a picture of the PCI Express cable and where it must be connected, see [PCI installation on page 79](#) “PCI or PCI Express Installation.”



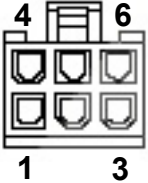

**NOTE** The 6-pin power (auxiliary PCI Express) is only required with high-powered graphics cards.

6-Pin power (auxiliary PCI Express)		Pin	Color	Signal
	1	YEL	+12V-C	
	2	YEL	+12V-C	
	3	YEL	+12V-C	
	4	BLK	GND	
	5	BLK	GND	
	6	BLK	GND	

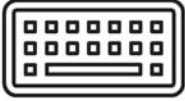

Keyboard connector		Pin	Signal
 	1 2 3	Data Unused Ground	
	4 5 6	+5 VDC Clock Unused	

Mouse connector		Pin	Signal
 	1 2 3	Data Unused Ground	
	4 5 6	+5VDC Clock Unused	



# D Appendix D — System board designators

This appendix lists the system board designators for this system.

Designator	Silkscreen	Component
MH02-03, MH06-09, MH14-15	N/A	Mounting holes
E14	BBLK_WP	Boot block header/jumper
E49	PSWD	Clear password header/jumper
J20	SLOT 5 PCI	PCI slot
J21	SLOT 6 PCI	PCI slot
J22	N/A	PCI slot
J33	SLOT 4	PCI Express slot
J31	SLOT 2	PCI Express slot
J32	SLOT 3	PCI Express slot
J41	SLOT 1	PCI Express x16 slot for graphics
P60-63, P66-67	SATA0, SATA1, SATA2	SATA Connectors
J50, P53	PAR/SER	Parallel port and serial port stack connector
J68	KBD MS PS2	Stacked keyboard/mouse connector
J9	RJ45/USB	Stacked RJ 45/dual USB
J10	USB	Quad stacked USB
J83	AUD	Triple stacked audio jack
SW50	CMOS	Clear CMOS switch/push button
P1	PWR	Power supply connector (24-pin)
P3	PWRCPU	Processor and memory 12V header
P10	FDD	Diskette driver connector
P11	AUX	Auxiliary audio connector
P20	PRIMARY IDE	Primary IDE connector
P23	FRNT AUD	Front panel audio header
P24	FRNT USB	Front panel USB header

Designator	Silkscreen	Component
P25	INT USB	Internal USB header
P29	HDD LED	HDD LED connector
P5	CONTROL PANEL	Main power/HDD LED/internal speaker connector
P70	CPUFAN1	Primary CPU fan header
P71	CPU2FAN	Secondary CPU fan header
P8	MEM FAN	Memory fan header
P130	CHASSIS FAN	Chassis fan header
P9	N/A	PCI fan header
P93	N/A	Front chassis fan header
XBT2	BAT	Battery retainer
XMM1	DIMM1	Memory slot
XMM2	DIMM3	Memory slot
XMM3	DIMM2	Memory slot
XMM4	DIMM4	Memory slot
U1	XU1	Primary processor socket
U2	XU2	Secondary processor socket
N/A	ROM	ROM socket
E15	RECOVER	Crisis recovery header/jumper

# E Appendix E — Routine care

## General cleaning safety precautions

- Never use solvents or flammable solutions to clean the workstation.
- Never immerse any component in water or cleaning solutions; apply any liquids to a clean cloth and then use the cloth on the component.
- Always unplug the workstation before cleaning the keyboard, mouse, or air vents.
- Always disconnect the keyboard before cleaning it.
- Wear safety glasses equipped with side shields when cleaning the keyboard.

## Maximizing the airflow

- Keep your workstation in an area where the airflow is not obstructed.
- Keep the unit off of surfaces where dust can gather.
- Keep the front of the unit clear of any obstruction.
- Remove any dust on the front panel (vent area) and the rear fans with a small vacuum, compressed air, or dust rag.
- Keep the back of the unit at least 0.15 m (6 in.) away from a wall or other obstruction.

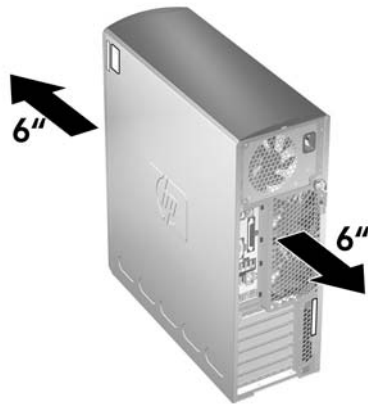

## Cleaning the workstation case

- Follow the safety precautions presented in [Service considerations on page 52](#) before cleaning the workstation.
- To remove light stains or dirt, use plain water with a clean, lint-free cloth or swab.
- For stronger stains, use a mild dish-washing liquid diluted with water. Rinse well by wiping it with a cloth or swab dampened with clear water.
- For stubborn stains, use isopropyl (rubbing) alcohol. No rinsing is needed because the alcohol will evaporate quickly and not leave a residue.
- After cleaning, always wipe the unit with a clean, lint-free cloth.
- Occasionally clean the air vents on the workstation. Lint and other foreign matter can block the vents and limit the airflow.



# Cleaning the keyboard



**CAUTION** Use safety glasses equipped with side shields before attempting to clean debris from under the keys.

---

- Follow the safety precautions presented in [Service considerations on page 52](#) before cleaning the keyboard.
- Visible debris underneath or between the keys can be removed by vacuuming or shaking.
- Canned, pressurized air can be used to clean debris from under the keys. Use caution because too much air pressure can dislodge lubricants applied under the wide keys.
- If you remove a key, use a specially designed key puller to prevent damage to the keys. This tool is available through many electronic supply outlets.



**CAUTION** Never remove a wide leveled key (like the space bar) from the keyboard. If these keys are improperly removed or installed, the keyboard might not function properly.

---

- Clean under a key with a swab moistened with isopropyl alcohol and squeezed out. Be careful not to wipe away lubricants necessary for proper key functions. Allow the parts to air dry before reassembly.
- Use tweezers to remove any fibers or dirt in confined areas.

## Cleaning the monitor

- Follow the safety precautions presented in [Service considerations on page 52](#) before cleaning the keyboard.
- To clean the monitor, wipe the monitor screen with a towelette designed for cleaning monitors or a clean cloth moistened with water.



---

**CAUTION** Do not use sprays or aerosols directly on the screen—the liquid might seep into the housing and damage a component.

Never use solvents or flammable liquids on the monitor because display or housing damage may result.

---

## Cleaning the mouse

1. Follow the safety precautions presented in [Service considerations on page 52](#) before cleaning the mouse.
2. Remove the mouse ball from the housing by removing the retaining plate.
3. Clean the mouse ball.
4. Pull out any debris from the ball socket, and wipe the ball with a clean, dry cloth.
5. Reassemble the mouse.



# F Appendix F — Additional password security and resetting CMOS

This workstation supports the following security password features, which can be established through the Computer Setup Utilities menu:

- Setup password
- Power-on password

When you establish a setup password, only the power-on password is required to access Computer Setup and any other information on the workstation. When you establish both passwords, only the setup password will give you access to Computer Setup.

When both passwords are set, the setup password can also be used in place of the power-on password as an override to log in to the workstation, which is a useful feature for a network administrator.

If you forget the password for the computer, two methods are available for clearing that password so you can gain access to the information on the workstation:

- Reset the password jumper
- Use the **Clear CMOS** button



---

**CAUTION** Pushing the CMOS button resets CMOS values to factory defaults and erases any customized information, including passwords, asset numbers, and special settings. It is important to back up the workstation CMOS settings before resetting them in case they are needed later. To back up the CMOS settings, use Computer Setup and run the Save to Diskette option from the File menu.

---

# Resetting the password jumper

To disable the power-on or setup password features and clear the power-on and setup passwords:

1. Shut down the operating system, and power off the workstation and any external devices. Disconnect the power cord of the workstation and any external devices from the power outlets.
2. Disconnect the keyboard, monitor, and any other external devices that are connected to the workstation.



---

**WARNING!** To reduce the risk of personal injury from electrical shock and hot surfaces, be sure to disconnect the power cord from the wall outlet and allow the internal system components to cool before touching.

---



---

**CAUTION** When the workstation is plugged in, the power supply always has voltage applied to the system board even when the unit is turned off. Failure to disconnect the power cord can result in damage to the system.

---

**CAUTION** Static electricity can damage the electronic components of the workstation or optional equipment. Before beginning these procedures, be sure that you are discharged of static electricity by briefly touching a grounded metal object.

---

3. Remove the access panel.
4. Locate the password header and jumper. The password header is E49.



---

**NOTE** The password jumper is green so that it can be easily identified. For assistance locating the password jumper and other system board components, see [System board components on page 58](#) “System Board Components.”

---

5. Remove the jumper from either pin 1 or 2. Place the jumper on pins 1 and 2 (connecting both pins together).
6. Replace the access panel.
7. Reconnect the external equipment.
8. Plug in and power on the workstation. Allow the operating system to start. This process clears the current passwords and disables the password features.
9. To establish new passwords, repeat steps 1 through 4, replace the password jumper on either pin 1 or pin 2 (but not both), and repeat steps 6 through 8. Establish the new passwords in Computer Setup.

# Clearing and Resetting the CMOS

The CMOS of the workstation stores password information and information about the workstation configuration. This section describes the steps to successfully clear and reset the CMOS.

## Using the CMOS Button

1. Shut down the operating system, and power off the workstation and any external devices. Disconnect the workstation power cord and any external devices from the power outlets.
2. Disconnect the keyboard, monitor, and any other external devices that are connected to the workstation.



**WARNING!** To reduce the risk of personal injury from electrical shock and hot surfaces, be sure to disconnect the power cord from the wall outlet and allow the internal system components to cool before touching.

---



**CAUTION** When the workstation is plugged in, the power supply always has voltage applied to the system board even when the unit is powered off. Failure to disconnect the power cord can result in damage to the system

**CAUTION** Static electricity can damage the electronic components of the workstation or optional equipment. Before beginning these procedures, be sure that you are discharged of static electricity by briefly touching a grounded metal object.

---

3. Remove the access panel.



**CAUTION** Pushing the CMOS button resets CMOS values to factory defaults and erases any customized information, including passwords, asset numbers, and special settings. It is important to back up the workstation CMOS settings before resetting them in case they are needed later. To back up the CMOS settings, use Computer Setup and run the Save to Diskette option from the File menu.

---

4. Locate, press, and hold the CMOS button in for five seconds.



**NOTE** Be sure that the AC power cord is disconnected from the power outlet. The CMOS button does not clear CMOS if the power cord is connected.

**NOTE** For assistance locating the CMOS button and other system board components, see [System board components on page 58](#) "System Board Components."

---

5. Replace the access panel.
6. Reconnect any external devices.
7. Plug in and power on the workstation.



**NOTE** The workstation passwords and any special configurations along with the system date and time will have to be reset.

---

## Using Computer Setup to Reset CMOS

1. To reset CMOS using Computer Setup, access the Computer Setup (F10) Utilities menu. When the Computer Setup message appears in the lower-right corner of the screen, press the **F10** key. Press **Enter** to bypass the title screen, if necessary.



---

**NOTE** If you do not press the **F10** key while the message is displayed, the workstation must be powered off, then on again, to access the utility.

---

2. From the Computer Setup menu, select **File>Set Defaults** and **Exit**. This restores the soft settings that include boot sequence order and other factory settings. It does not, however, force hardware rediscovery.



---

**NOTE** The workstation passwords and any special configurations, along with the system date and time, will have to be reset.

---



# G Appendix G — Quick troubleshooting flowcharts

This appendix presents some quick troubleshooting flowcharts for the following issues:

- Initial troubleshooting
- No power
- No video
- Error messages
- No OS loading
- No OS loading from hard drive
- No OS loading from diskette drive
- No OS loading from CD-ROM drive
- No OS loading from network
- Non-functioning device



---

**NOTE** The flowcharts presented are for general troubleshooting purposes only and they might not apply to your specific workstation.

---

## Initial troubleshooting

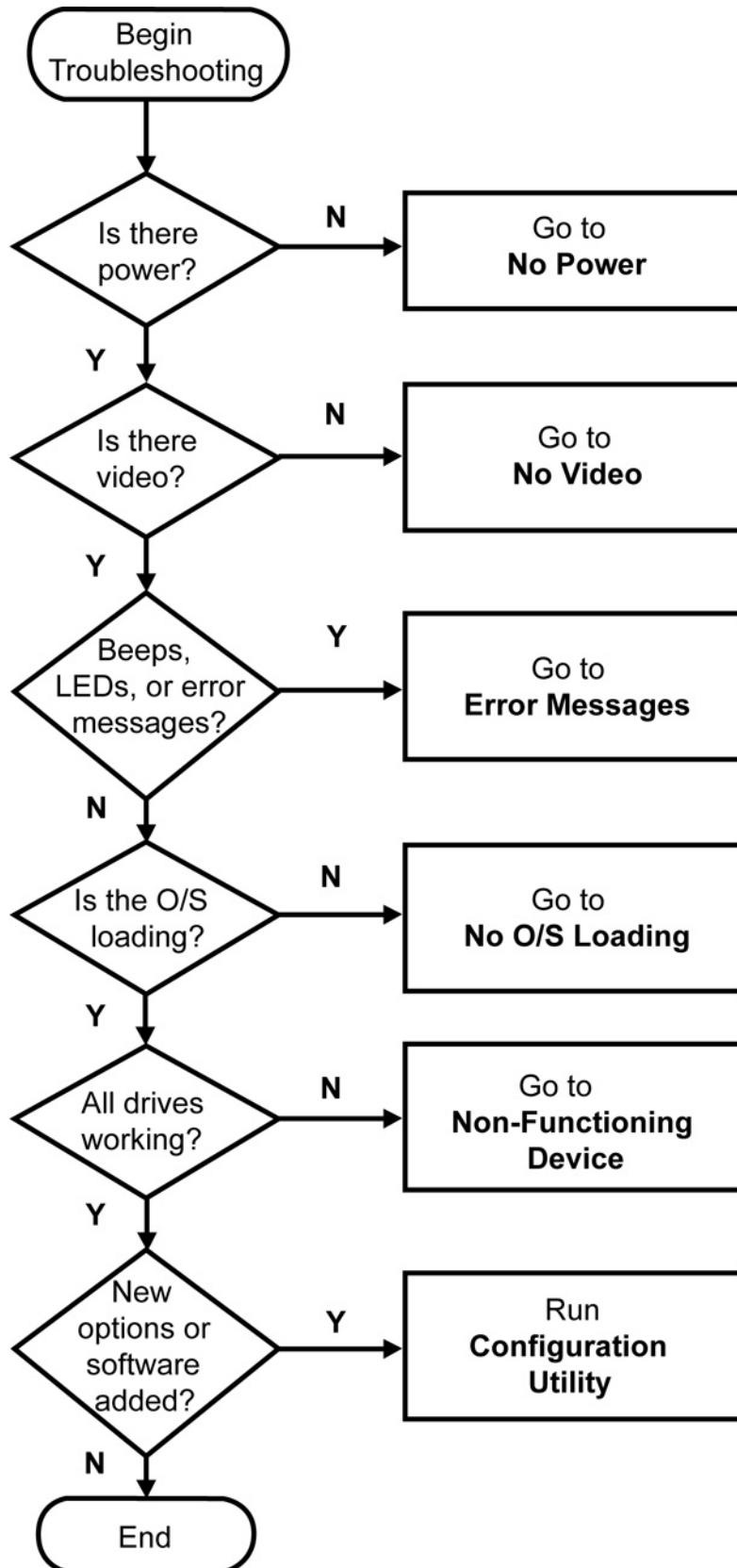

# No power

## No power, part 1

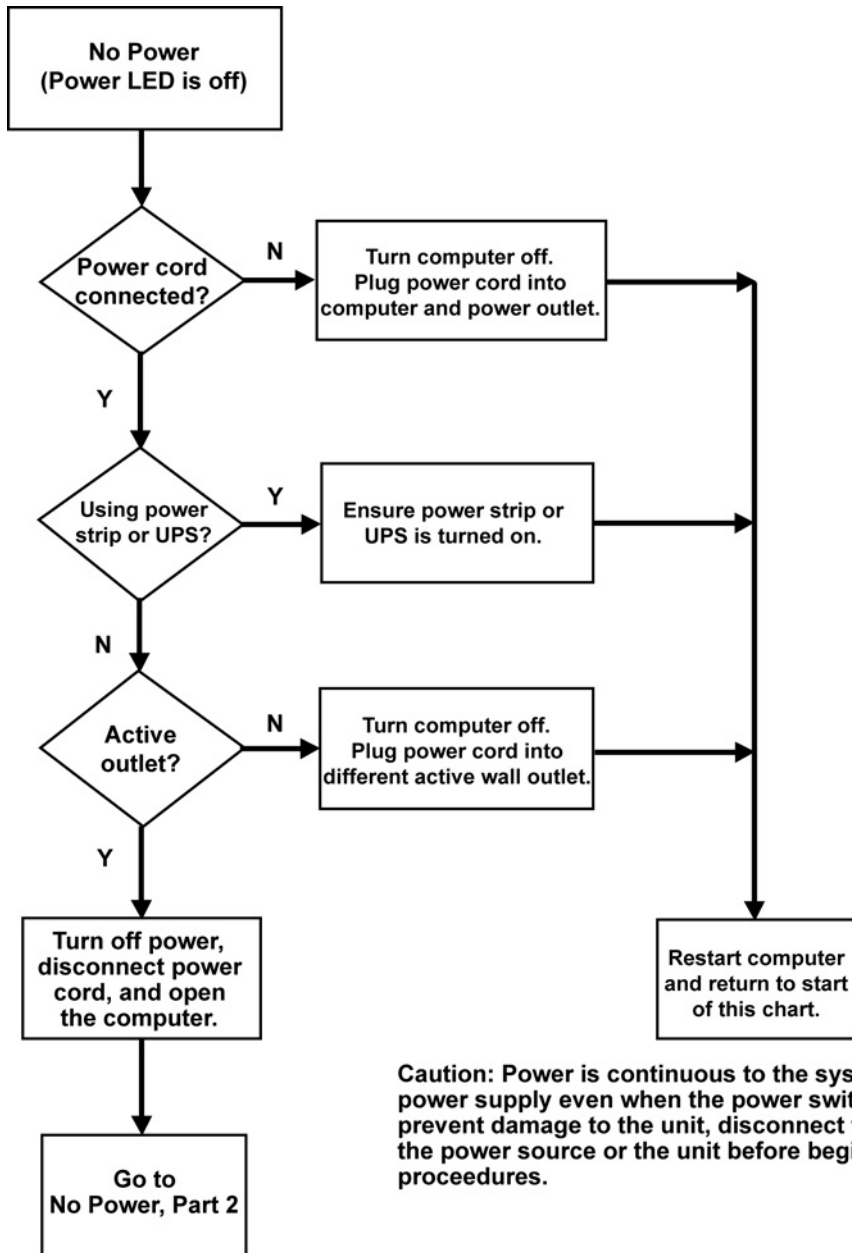

**Caution:** Power is continuous to the system board and power supply even when the power switch is turned off. To prevent damage to the unit, disconnect the power cord from the power source or the unit before beginning disassembly procedures.

## No power, part 2

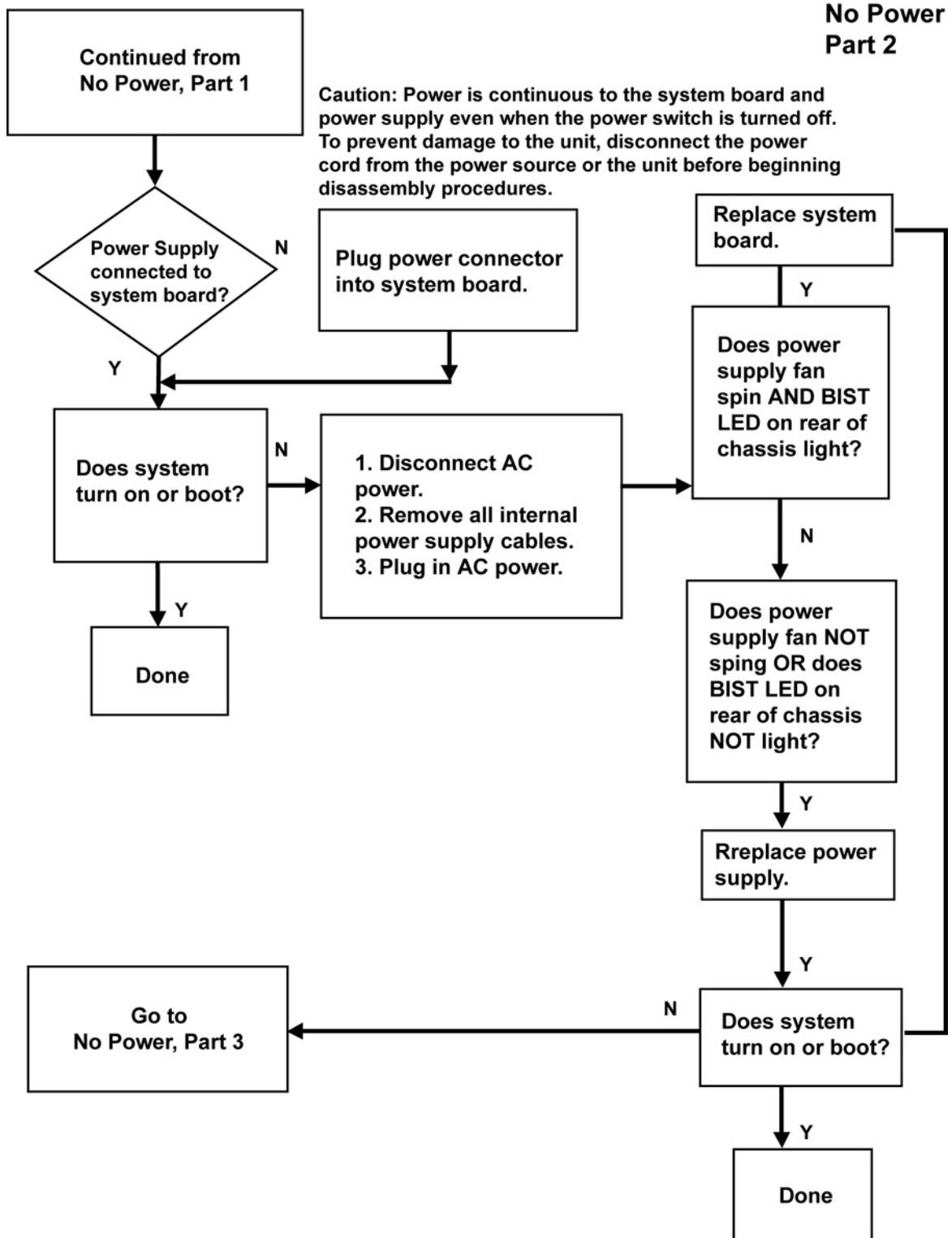

## No power, part 3

### No Power Part 3

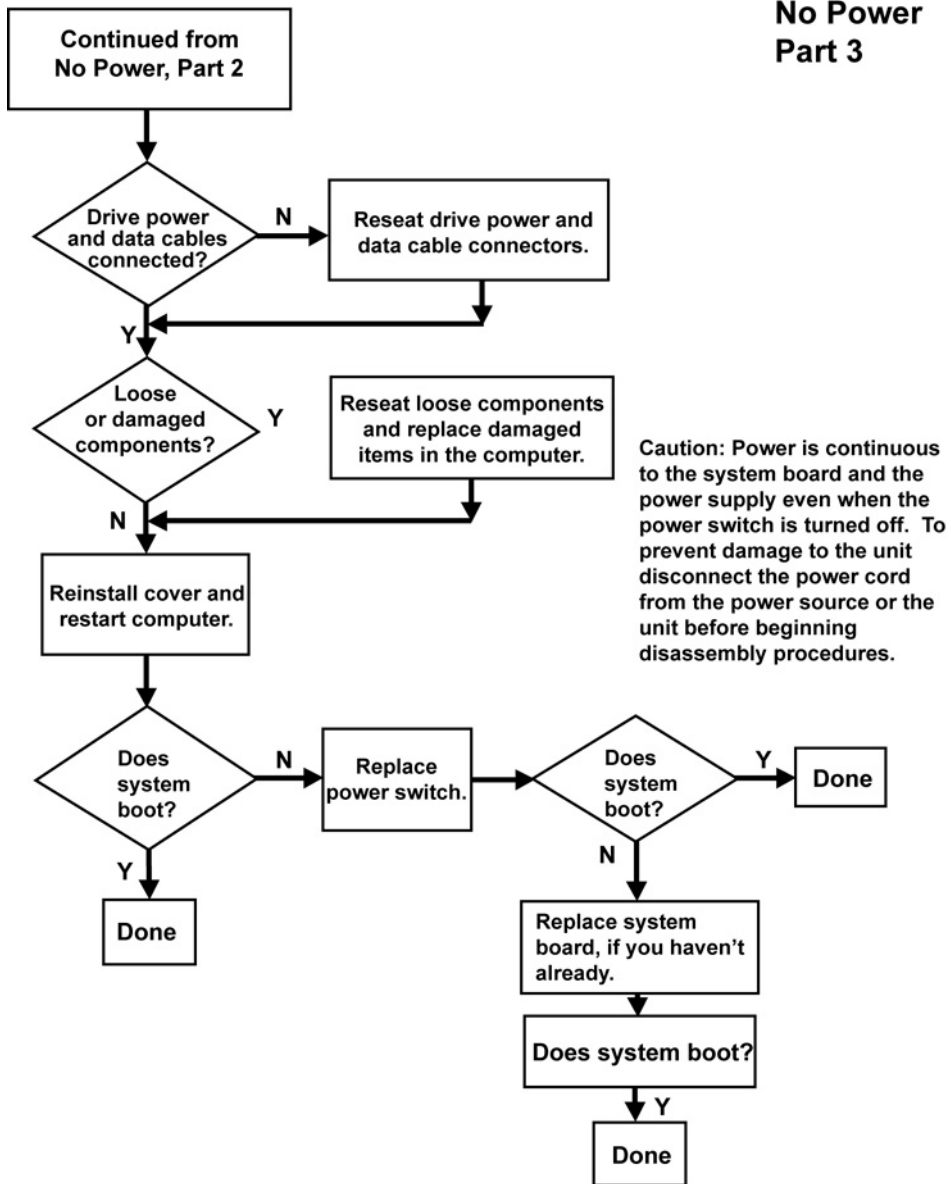

# No video

## No video, part 1

### No Video Part 1

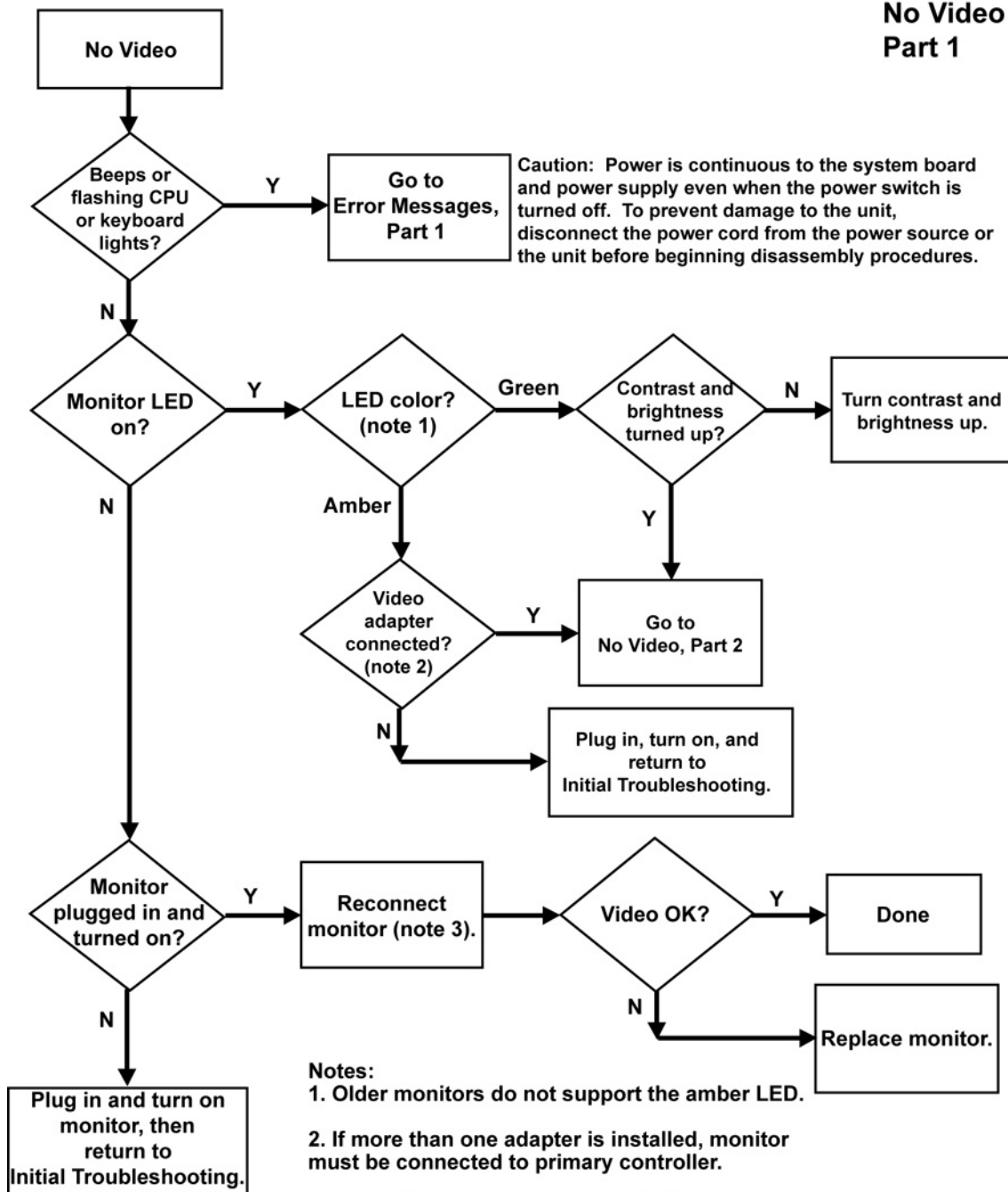

## No video, part 2

## No Video Part 2

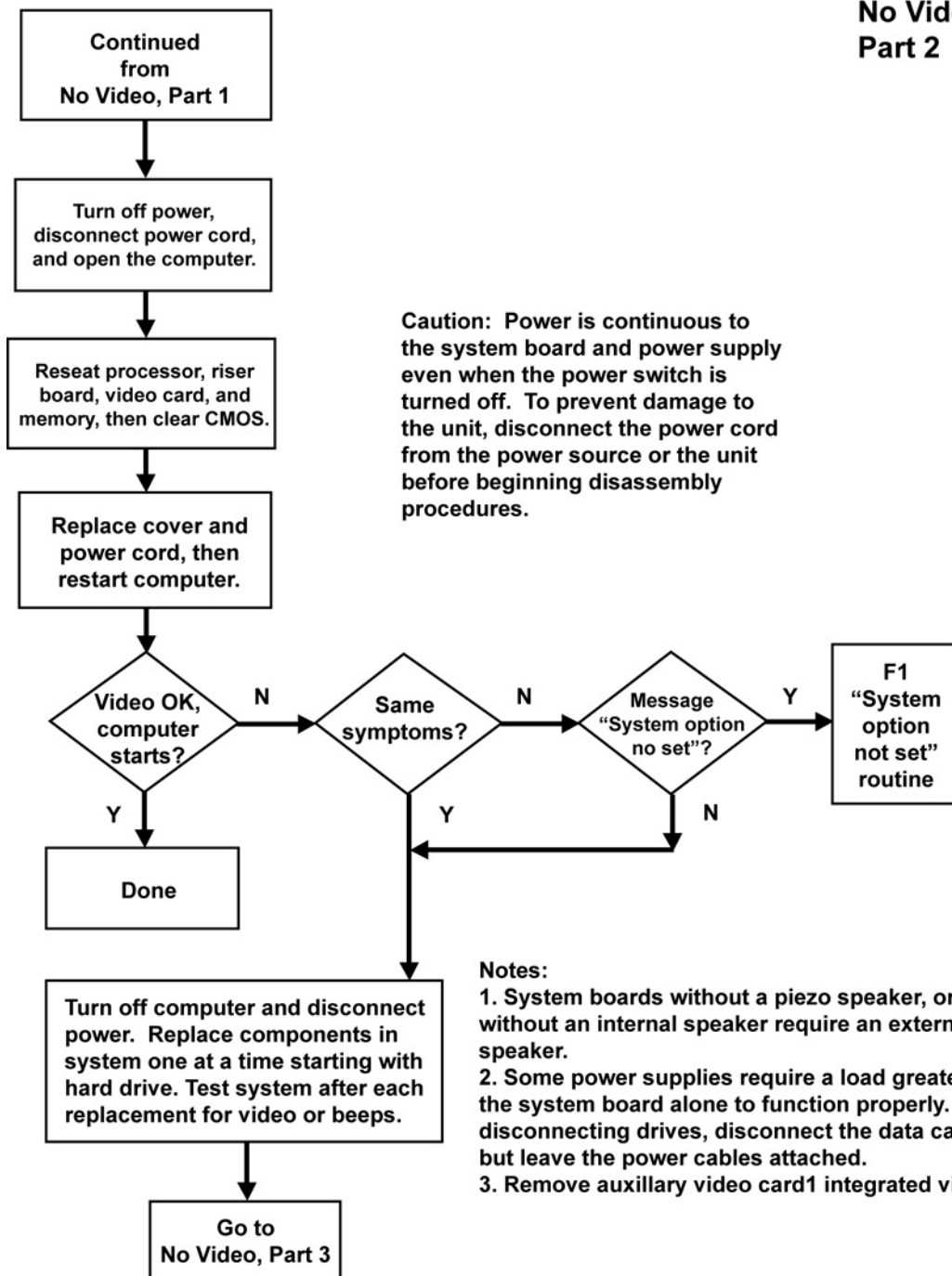

## No video, part 3

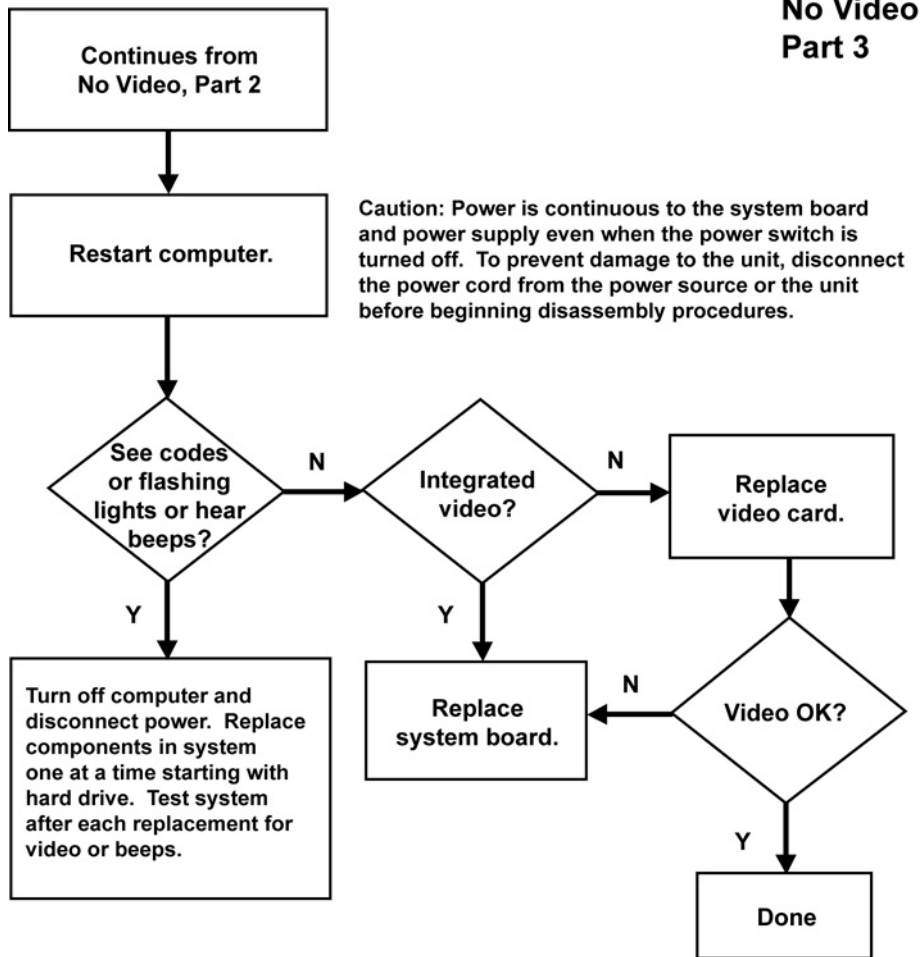



# Error messages

## Error messages, part 1

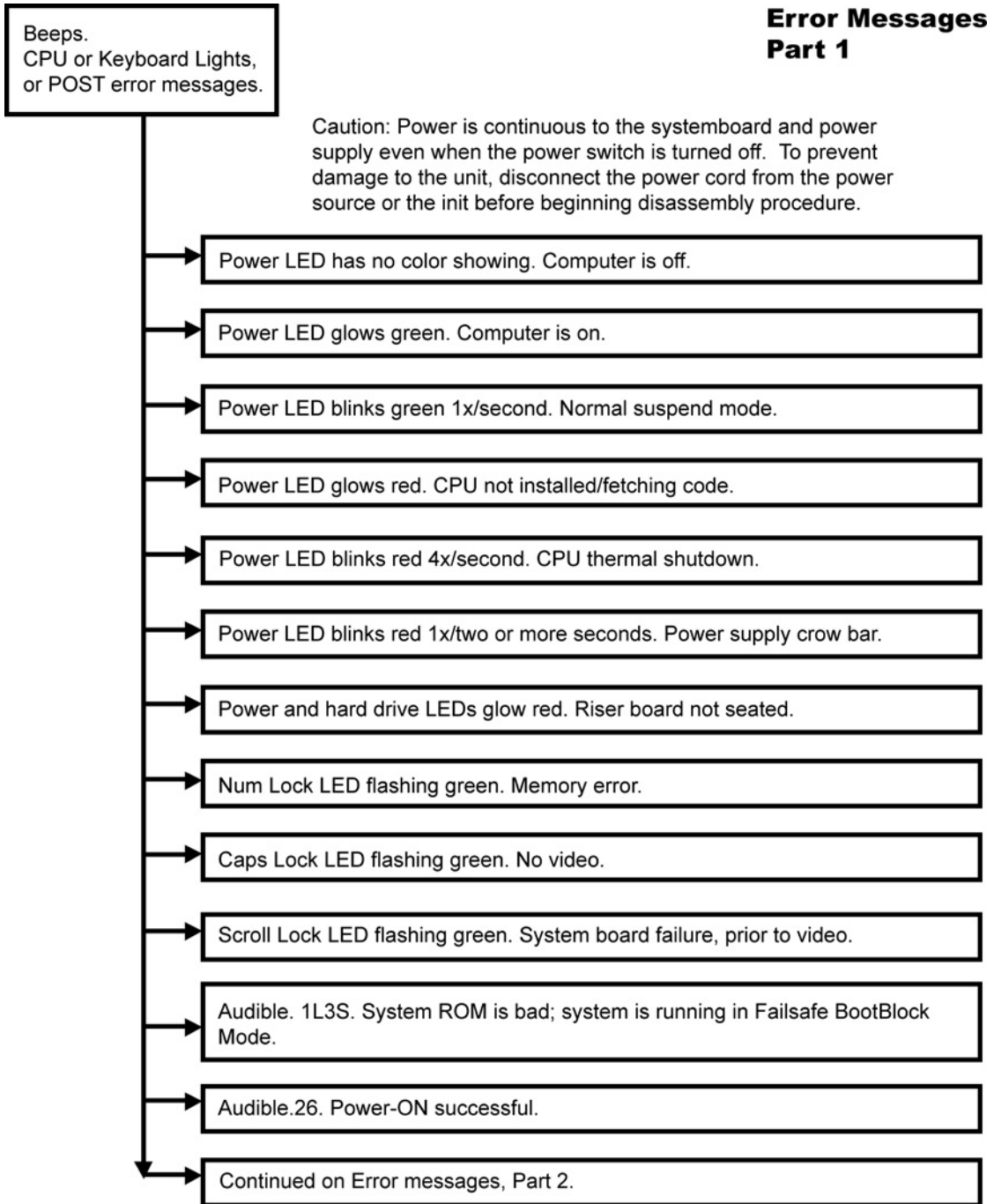

Notes: Short (S) and long (L) beeps will only be heard if the system has a speaker.  
LEDs will only function on PS/2 keyboards, not USB.

**Error Messages  
Part 2**

Continued from  
Error Messages, Part 1

Caution: Power is continuous to the systemboard and power supply even when the power switch is turned off. To prevent damage to the unit, disconnect the power cord from the power source or the init before beginning disassembly procedure.

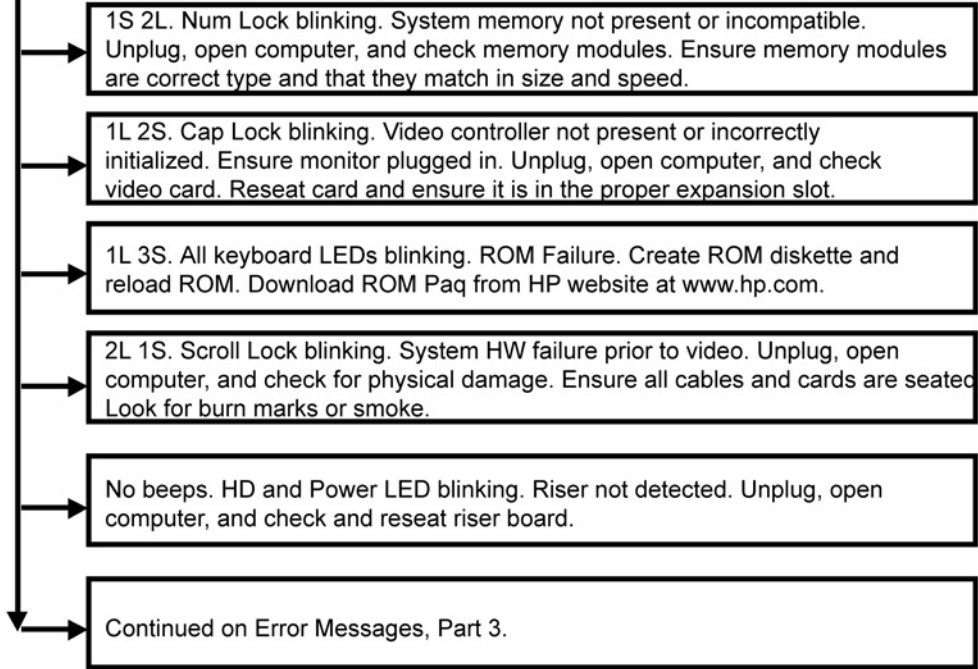

Notes: Short (S) and long (L) beeps will only be heard if the system has a speaker.  
LEDs will only function on PS/2 keyboards, not USB.

## Error messages, part 3

### Error Messages Part 3

Continued from  
Error Messages, Part 2

Caution: Power is continuous to the systemboard and power supply even when the power switch is turned off. To prevent damage to the unit, disconnect the power cord from the power source or the init before beginning disassembly procedure.

Error 162. 2S Beeps System Option not set. Select F1. If error occurs after reboot, unplug and open computer and check CMOS jumper setting.

Error 163. Time & Date Not Set. Set time and date in F10 or boot OS and set time and date. If error occurs after reboot, unplug and open computer, then check CMOS setting.

Error 2xx. Memory Error. Unplug, open computer and reseal memory modules. Ensure modules are correct type and that they match in size and speed.

Error 30x. Keyboard Error. Do not type on keyboard before POST. Ensure keyboard connected to proper connector.

Error 6xx. Floppy Error. Unplug, open computer, check diskette drive, and check and reseal power and data cables.

Error 91x. Misc. Connection Error. Unplug, open computer, and check hood lock coil, thermal sensor pigtail, and riser for good connection.

Error 178x. Fixed Disk Error. Unplug, open computer, check hard drive and check and reseal power and data cables.

Error 1800. Thermal Alert. system overheating. Let computer cool off. Ensure processor has heatsink installed and that speed setting on system board is correct. Remove obstructions to air vents.

All others POST error messages - refer to Chapter 5 for definitions and solutions.

Notes: Short (S) and long (L) beeps will only be heard if the system has a speaker.  
LEDs will only function on PS/2 keyboards, not USB.  
x = Numbers 1 - 9

# No operating system loading

## No OS Loading

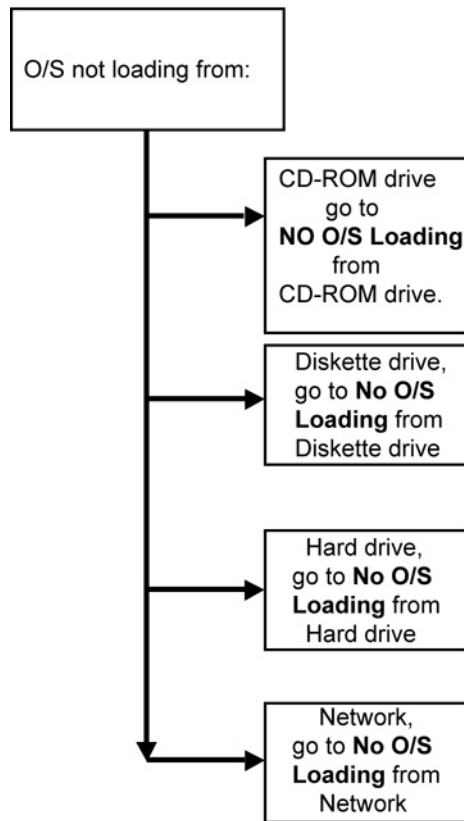

### Factory recommended booting priority

1. CD-ROM drive
2. Diskette drive
3. Hard drive
4. Network

**NOTE:** Before beginning, always check drive jumpers, cable connections, cable ends, and drives for bent or damaged pins.

# No operating system loading from hard drive

## No operating loading from hard drive, part 1

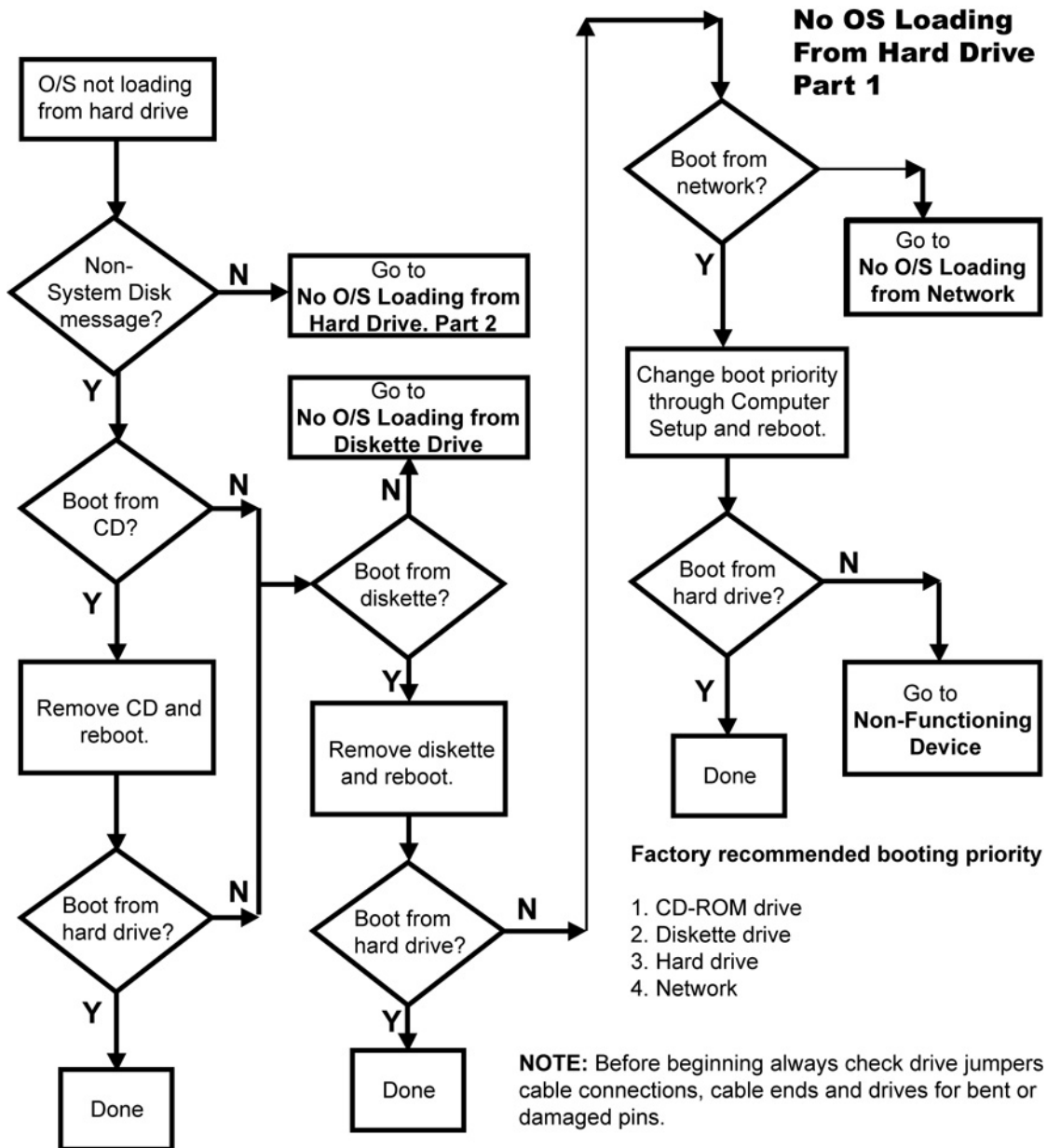

## No operating system loading from hard drive, part 2

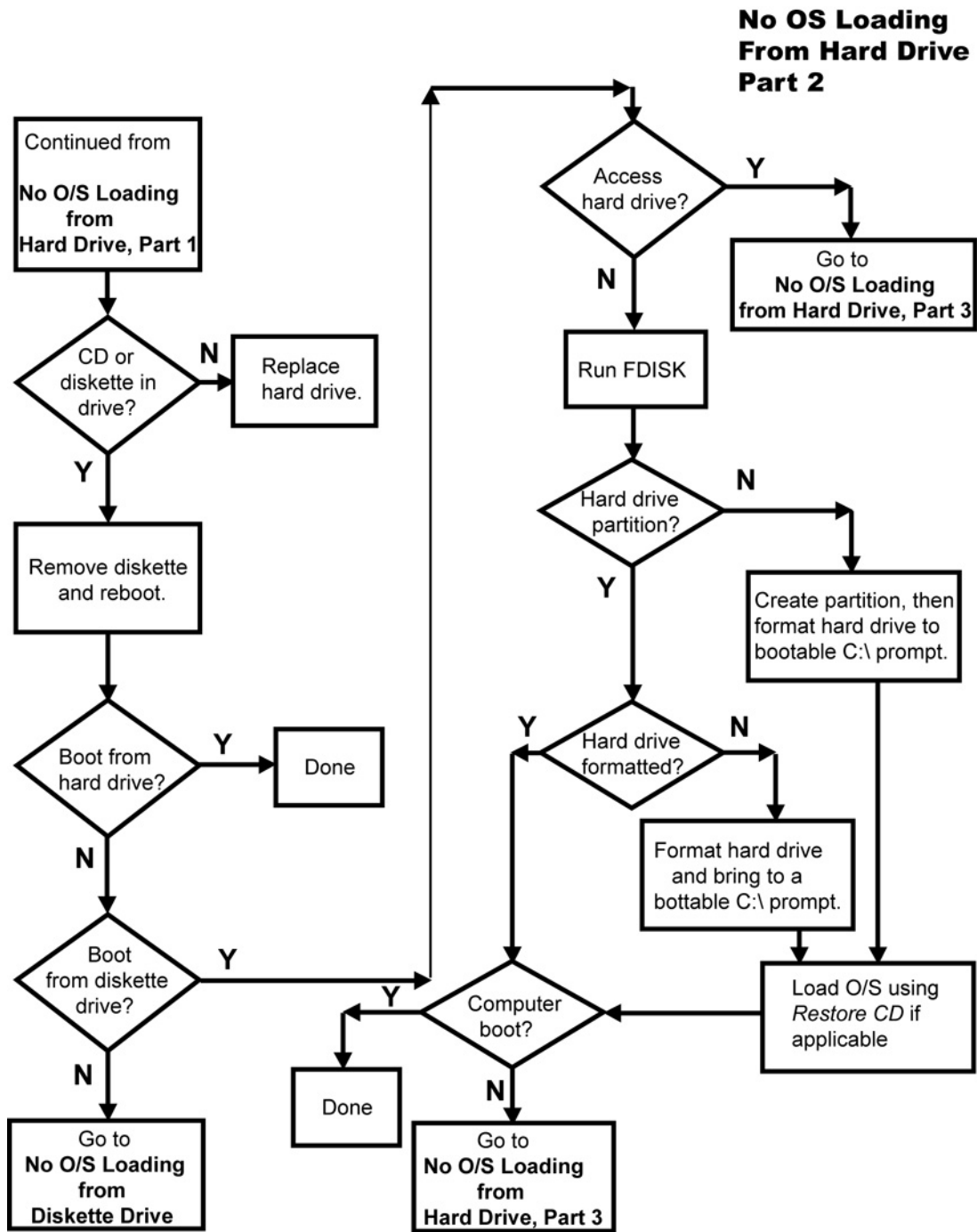

## No operating system loading from hard drive, part 3

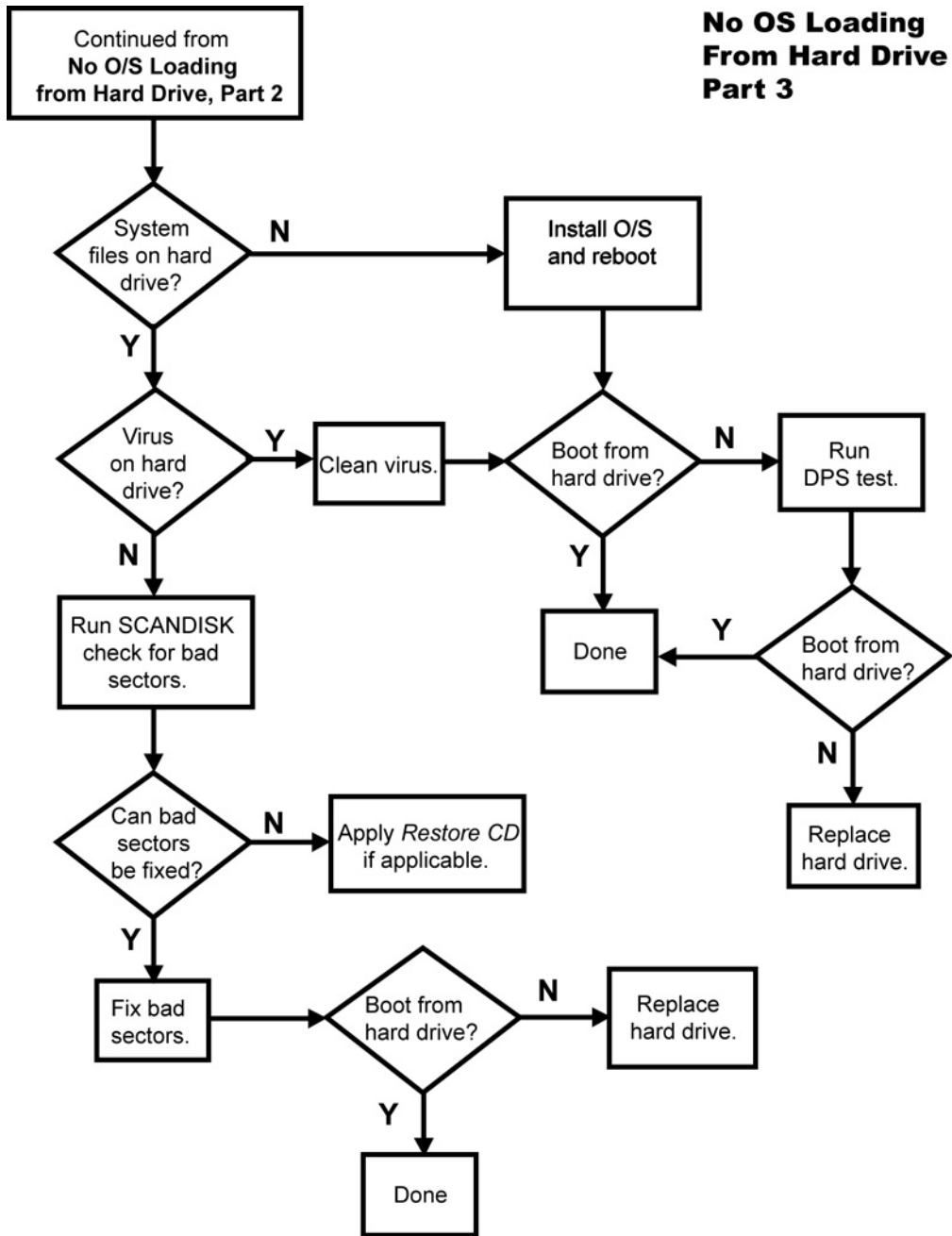

# No operating system loading from diskette drive

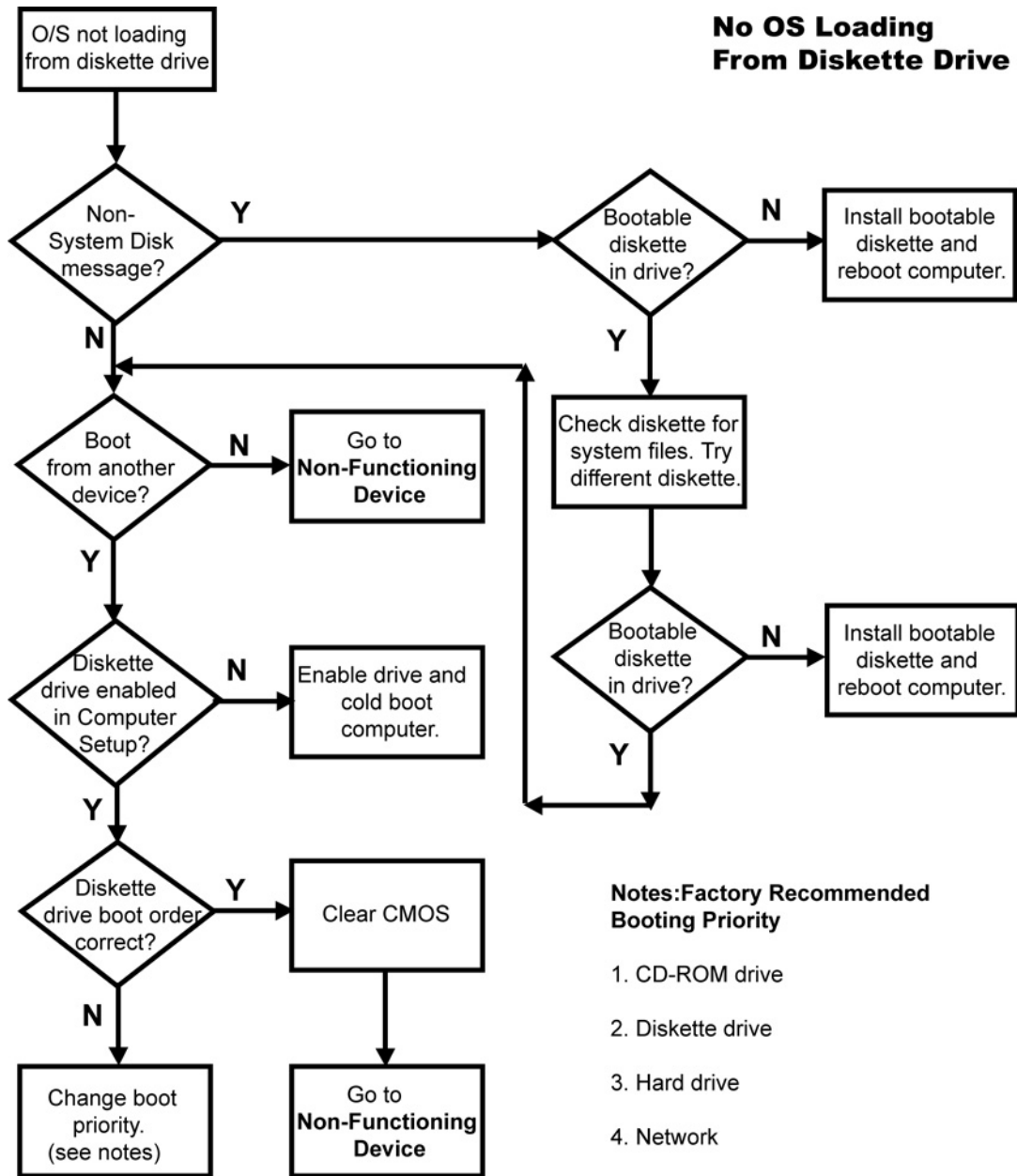

- Notes: Factory Recommended Booting Priority**
1. CD-ROM drive
  2. Diskette drive
  3. Hard drive
  4. Network



# No operating system loading from CD-ROM drive

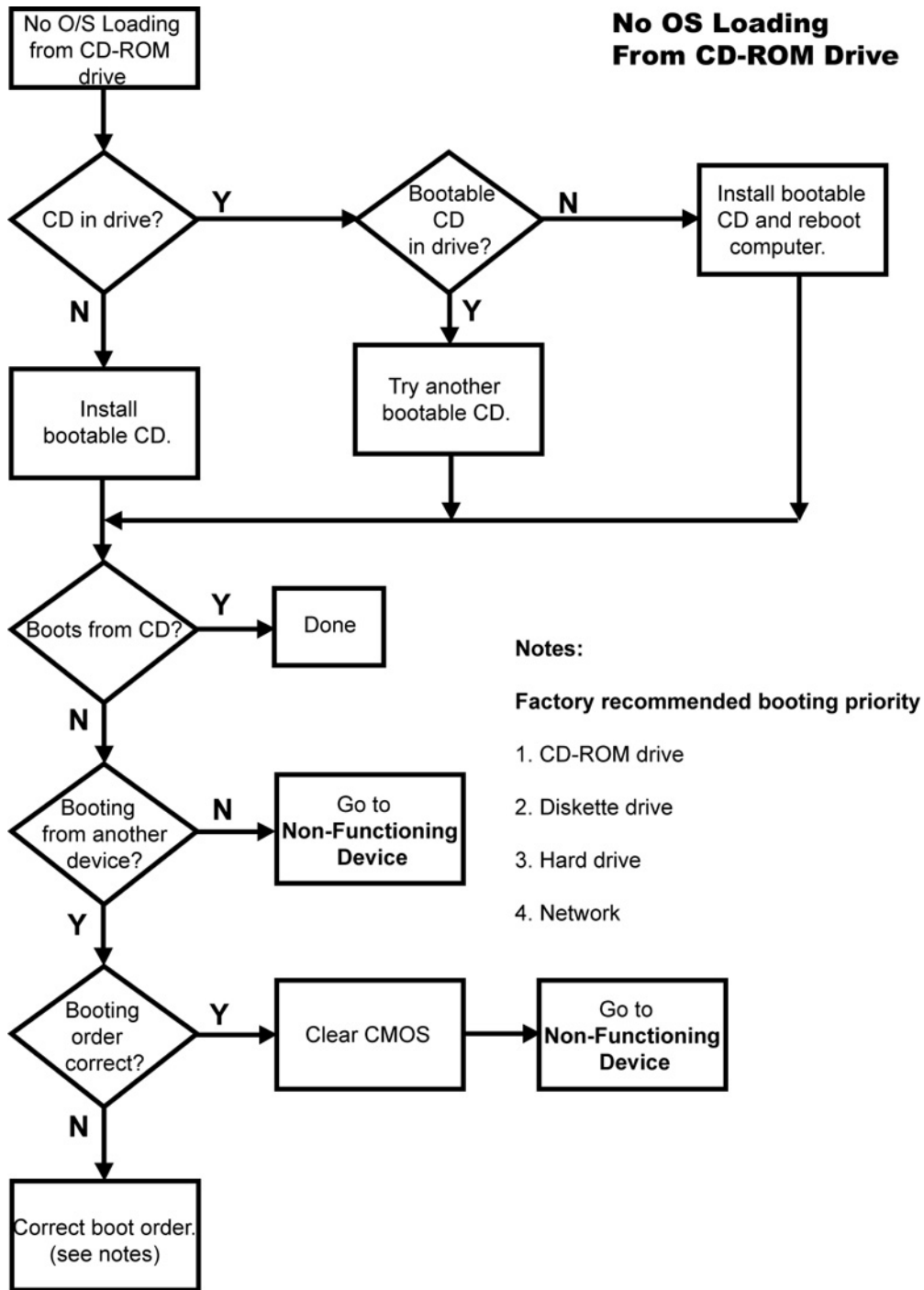

# No operating system loading from network

## No OS Loading From Network

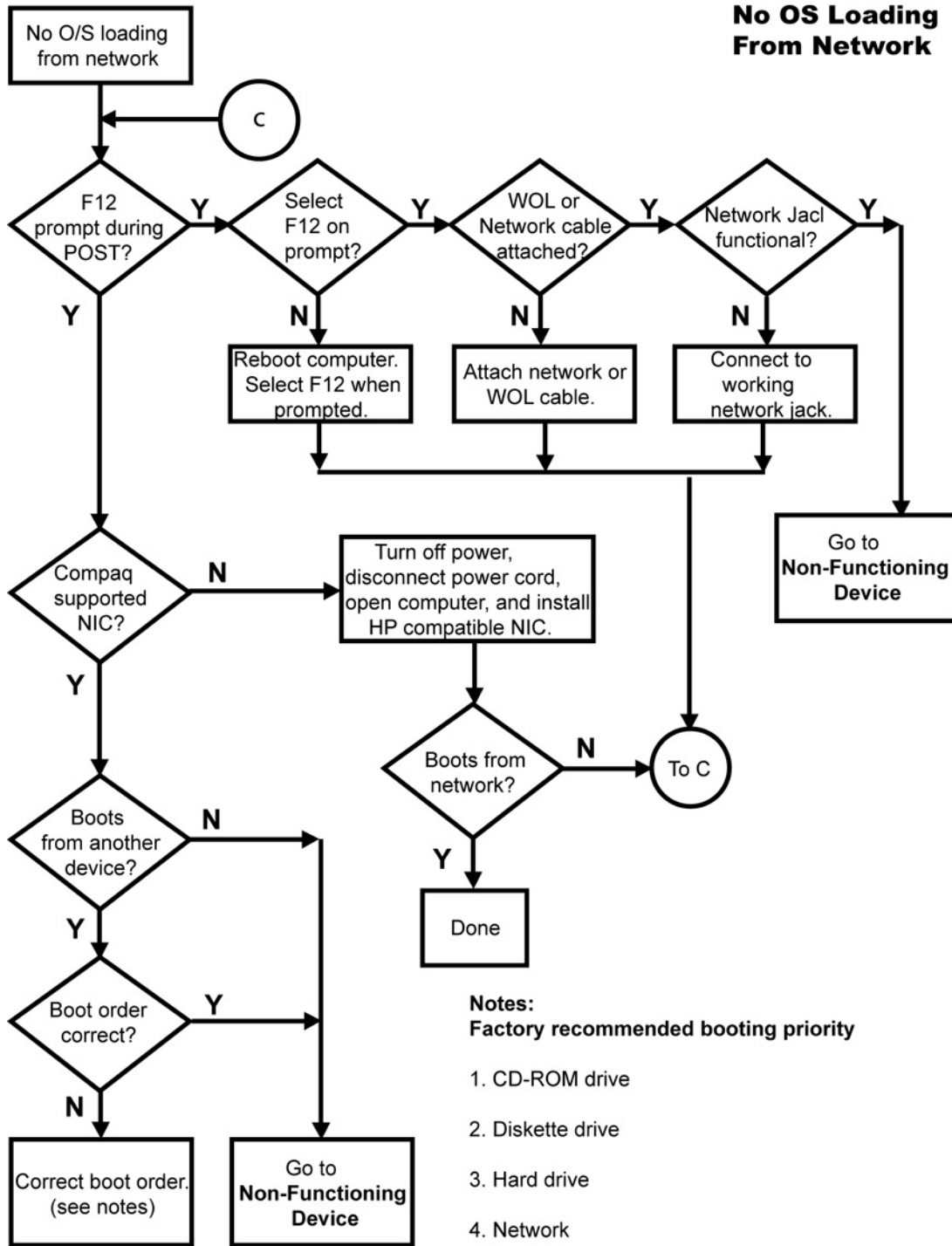

# Non-functioning device

## Non-Functioning Device

**Caution:** Power is continuous to the system board and power supply even when the power switch is turned off. To prevent damage to the unit, disconnect the power cord from the power source or the unit before beginning disassembly procedures.

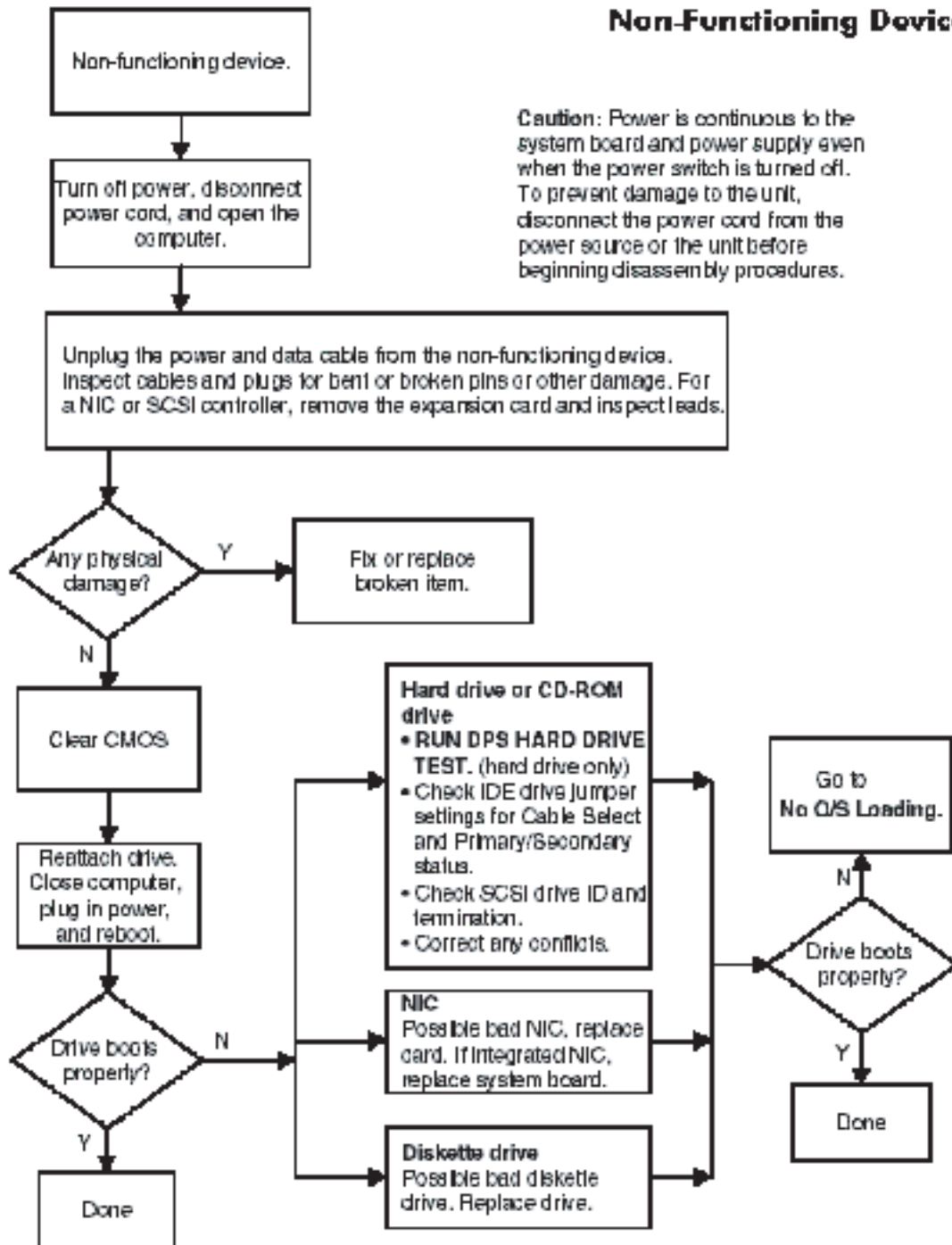



# H Appendix H — PCI bus layout

# PCI bus layout and device list

The following illustration shows the HP xw6400 Workstation PCI bus layout. It is followed by a PCI device list description.

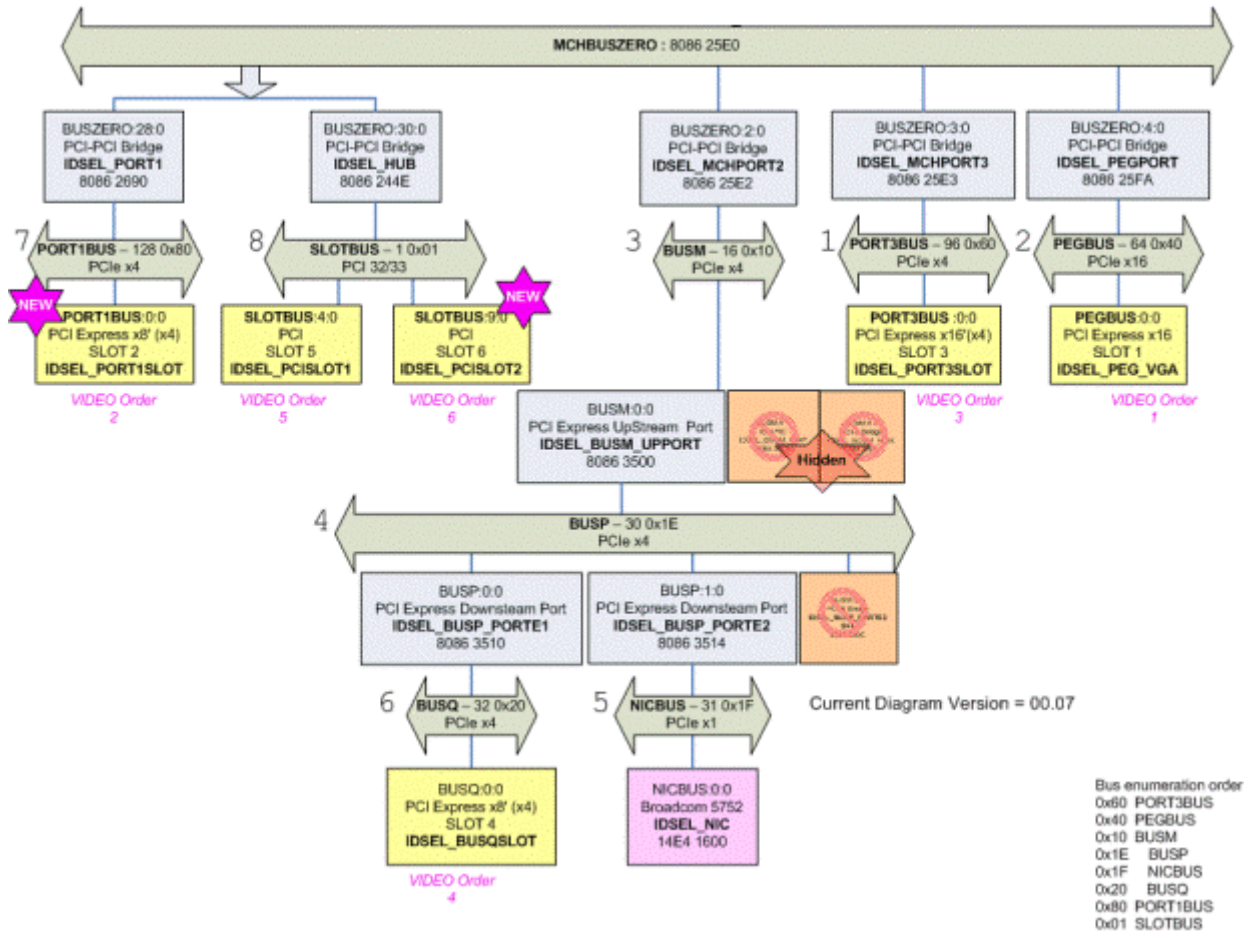

Figure H-1 PCI bus layout

Table H-1 PCI device list

Bus#	Dev#	Fn#	Device#
0	0	0	Port 0, ESI host bridge
0	2	0	Port 2, PCI Express x4 to ESB2 (secondary bus: M)
0	3	0	Port 3, PCI Express x4 (x16') to slot 3 (secondary bus: 96)
0	4	0	Port 4, PCI Express x16 to slot 1 (secondary bus: 64)
0	5	0	Port 5, slave port of port 4
0	6	0	Port 6, slave port of port 4
0	7	0	Port 7, slave port of port 4
0	8	0	Crystal beach DMA controller (unused, hidden)

**Table H-1** PCI device list (continued)

Bus#	Dev#	Fn#	Device#
0	9	0	Advanced memory buffer memory-mapped registers (visible via JTAG/SMBus only)
0	16	0	FSB controller, interrupt and system address registers
0	16	1	Address mapping, memory control, error logs
0	16	2	FSB error registers
0	17	0	Coherency engine and data manager registers
0	19	0	Debug and miscellaneous registers
0	21	0	FBD branch 0 memory map, error flag/mask, and channel control registers
0	22	0	FBD branch 1 memory map, error flag/mask, and channel control registers
0	27	0	High definition audio controller
0	28	0	Port 1 PCI Express x4 to slot 2 (secondary bus: 8)
0	28	1	(PCI Express port 2, hidden)
0	28	2	(PCI Express port 3, hidden)
0	28	3	(PCI Express port 4, hidden)
0	29	0	USB UHCI controller #1
0	29	1	USB UHCI controller #2
0	29	2	USB UHCI controller #3
0	29	3	USB UHCI controller #4
0	29	7	USB 2.0 EHCI controller
0	30	0	PCI to PCI bridge (secondary bus: 1, to slot 5 and 6)
0	30	2	AC97 audio controller
0	31	0	LPC controller
0	31	1	IDE controller
0	31	2	SATA controller
0	31	3	SMBus controller
1	4	x	Slot 5 (PCI)
1	9	x	Slot 6 (PCI)
M(16)	0	0	PCI Express upstream port (secondary bus: P)
P(30)	0	0	PCI Express downstream port E1 (secondary bus: Q) to slot 4 (x8')
P(30)	1	0	PCI Express downstream port E2 (secondary bus: NIC) to LOM
P(30)	2	0	PCI Express downstream port E3 (secondary bus: S, internal, not used)
31	0	0	Broadcom LOM (NIC)

**Table H-1** PCI device list (continued)

Bus#	Dev#	Fn#	Device#
32	0	x	Slot 4 (PCI Express x4 (x8') behind ESB2 P:0:0)
64	0	x	Slot 1 (PCI Express x16 behind MCH 0:4:0)
96	0	x	Slot 3 (PCI Express x4 (x16') behind MCH 0:3:0_
128	0	x	Slot 2 PCI Express x4, (behind MCH 0:28:0)